

PROJECT NO.	SHEET NO.
STP-S16B(103)	1
▲ CONTROL NO.	80939
▲ CONTROL NO.	
■ CONTROL NO.	

**STATE OF NEBRASKA
DEPARTMENT OF ROADS
PLANS FOR CONSTRUCTION
HACKBERRY LAKE
NORTHWEST
CHERRY COUNTY**



THE 2007 EDITION OF THE NEBRASKA STANDARD SPECIFICATIONS AND THE SPECIAL PROVISIONS APPLY TO THIS PROJECT.

INDEX OF SHEETS

SHEET NO.

- 1 TITLE PAGE & SUMMARY OF QUANTITIES
- 2 TRAFFIC CONTROL PLAN--VEHICLE SIGNING FOR PAINT STRIPING
- 3 TEMPORARY PAVEMENT MARKING PLAN
- 4 TYPICAL PAVEMENT MARKING PLAN--5" PAVEMENT MARKING

STANDARD PLANS

- 920-R5 (2 SHEETS) TRAFFIC CONTROL, CONSTRUCTION AND MAINTENANCE
922-R8 (2 SHEETS) TRAFFIC CONTROL FOR ASPHALT SURFACING

SUMMARY OF QUANTITIES

**SPECIALTY ITEMS
GROUP 8**

ITEM	QUANTITY	UNITS
BARRICADE, TYPE II	1,700.000	BDAY
BARRICADE, TYPE III	80.000	BDAY
TEMPORARY SIGN DAY	80.000	EACH
SIGN DAY	940.000	EACH
TEMPORARY BROKEN LINES	356.000	STA
PERMANENT PAVEMENT MARKING, PAINT	104,100.000	LF
FLAGGING	10.000	DAY
FURNISHING AND OPERATING PILOT VEHICLE	5.000	DAY
MOBILIZATION	1.000	LS
CHIP SEAL AGGREGATE	782.000	CY
CHIP SEAL EMULSIFIED ASPHALT	31,270.000	GAL

THE WORK ON THIS PROJECT CONSISTS OF GROUPS

8-SPECIALTY

▲ GROUPS	8	ARE INCLUDED
IN THE LETTING OF	AUGUST 1, 2013	
▲ GROUPS		ARE INCLUDED
IN THE LETTING OF		
■ GROUPS		ARE INCLUDED
IN THE LETTING OF		

DESIGN DESIGNATION
MAINTENANCE
TRAFFIC
YEAR: 2013
ADT: 55

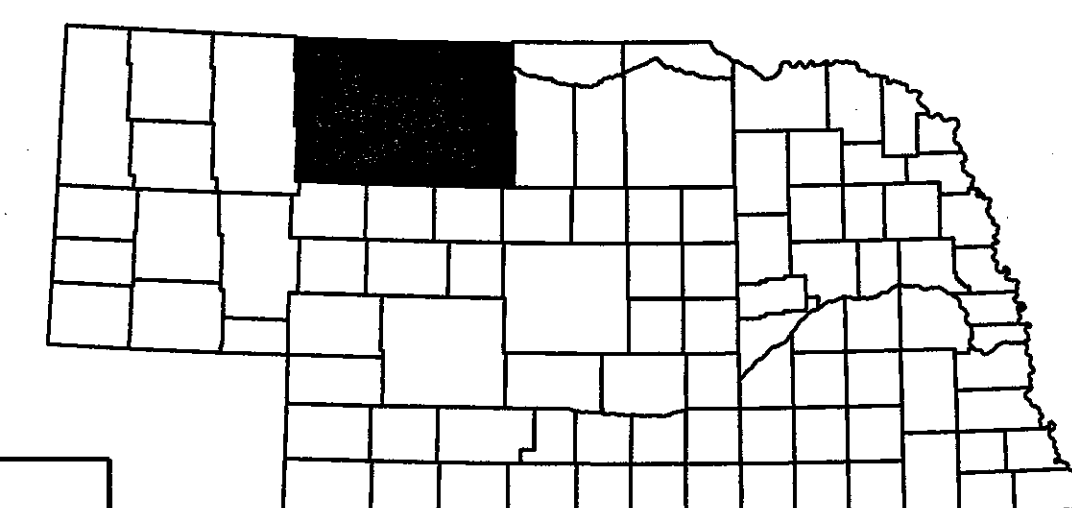
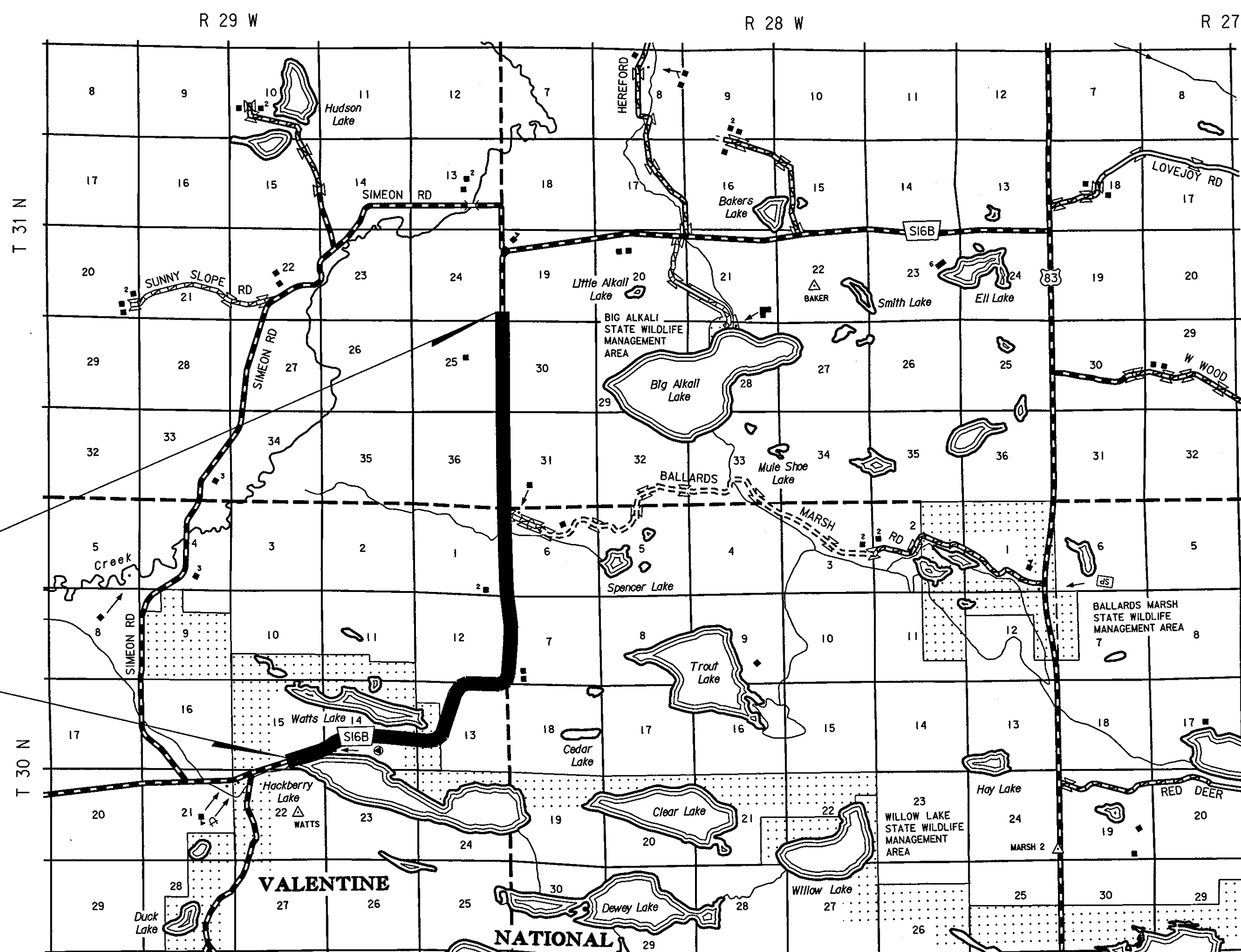

BEGIN PROJECT
R.P. 6+74

END PROJECT
R. P. 13+47

REFERENCE POST NO. 6+74 TO REFERENCE POST NO. 13+47

EXCEPTIONS: FROM STA. TO STA.

TOTAL NET LENGTH OF PROJECT: 35,534.40 FEET 6.730 MILES

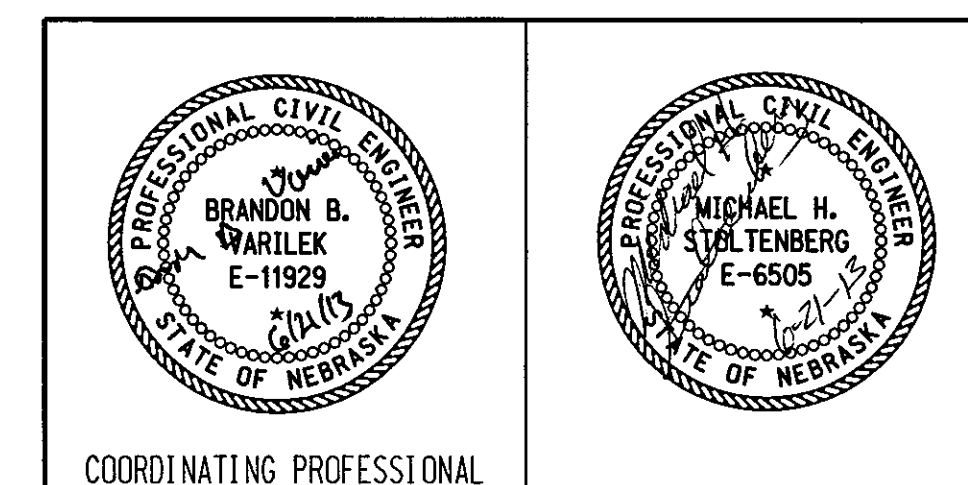

File: 809390psstH1e.dgn
 Scale: 1:100
 Date: 20-JUN-2013 11:46
 User: dorT7005
 Computer: DRCONSTRUCT24
 CONSTRUCTION DIVISION

CONVENTIONAL SIGNS

- FENCE R.O.W. OR WIRE
- GUARDRAIL
- TRAVELED WAY
- DIKE
- CULVERT
- POWER POLE
- TELEPHONE POLE
- MAILBOX
- RAILROAD TRACKS
- MARSH
- TREE - CONIFEROUS
- TREE - DECIDUOUS

R.O.W. LEGEND

- NEW CONTROLLED ACCESS
- PREVIOUS CONTROLLED ACCESS
- LIMITS OF CONSTRUCTION
- PREVIOUS R.O.W.
- NEW R.O.W.
- EXISTING PERMANENT EASEMENT
- TEMPORARY EASEMENT
- EXCESS TAKING
- PERMANENT EASEMENT
- EXISTING RAILROAD EASEMENT
- NEW RAILROAD PERMANENT EASEMENT
- NEW RAILROAD TEMPORARY EASEMENT

SIGNING PLAN

STRIPING ON RURAL TWO-LANE TWO-WAY ROADS

STRIPING ON RURAL MULTI-LANE ROADWAY

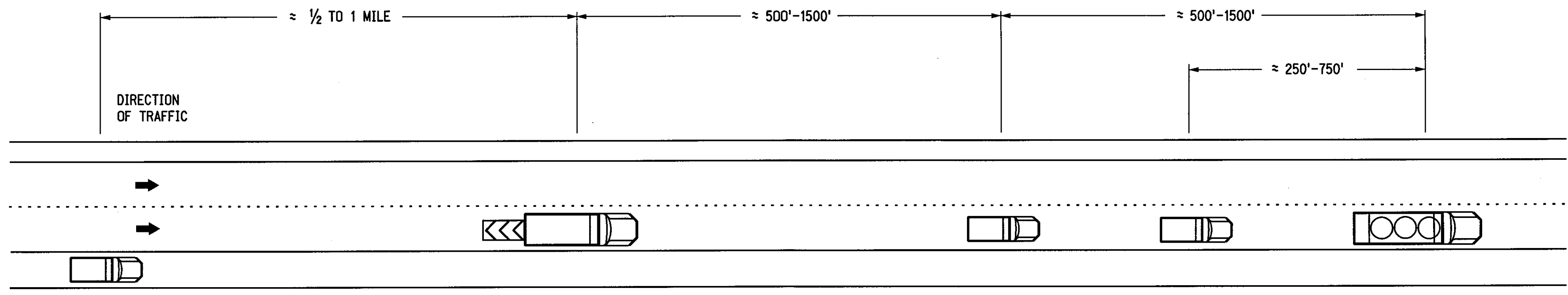
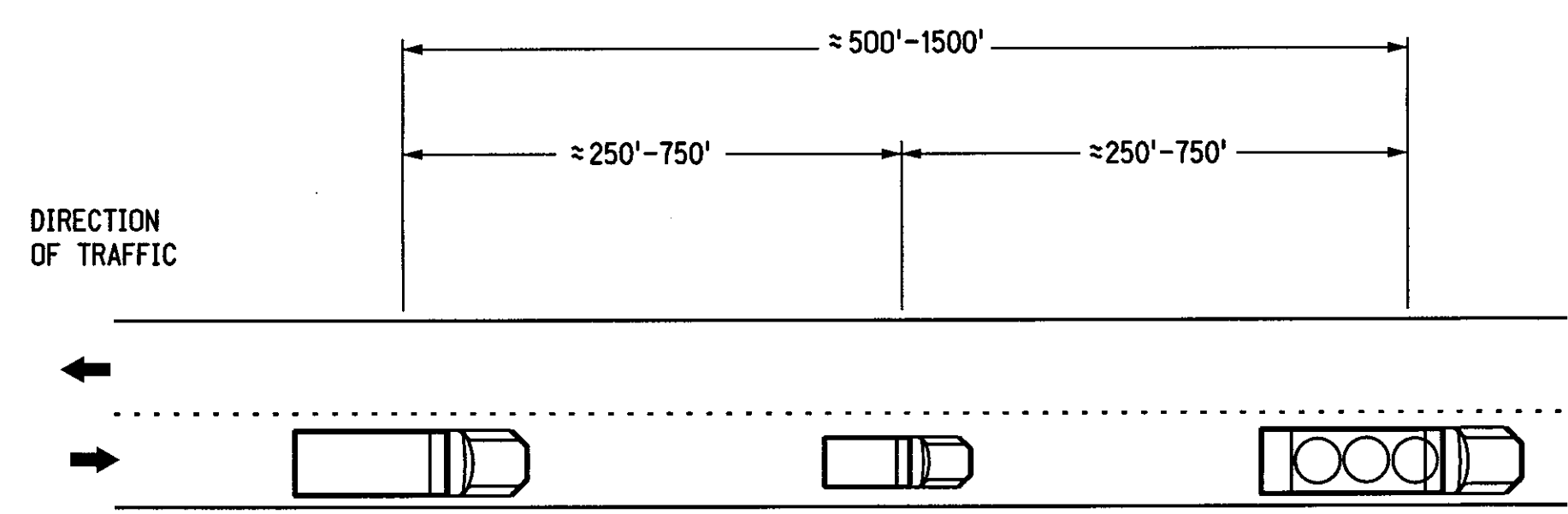

REAR VEHICLE WITH 2 HIGH INTENSITY FLASHING LIGHTS MOUNTED ON THE REAR AND 2-360° BEACONS OR APPROVED MINI-BAR LIGHT (TMA OPTIONAL)

OPTIONAL VEHICLE WITH 2-360° BEACONS OR APPROVED MINI-BAR LIGHT

STRIPING VEHICLE WITH 4 HIGH INTENSITY FLASHING LIGHTS MOUNTED ON REAR AND 2-360° BEACONS OR APPROVED MINI-BAR LIGHT

WARNING VEHICLE WITH 2 HIGH INTENSITY FLASHING LIGHTS MOUNTED ON REAR AND 2-360° BEACONS OR APPROVED MINI-BAR LIGHT

REAR VEHICLE W/TMA WITH 2 HIGH INTENSITY FLASHING LIGHTS MOUNTED ON THE REAR AND 2-360° BEACONS OR APPROVED MINI-BAR LIGHT

TRAILING VEHICLE WITH 2-360° BEACONS OR APPROVED MINI-BAR LIGHT AND OPTIONAL DRONE RADAR OR CB ALERT WARNING RADIO

OPTIONAL VEHICLE WITH 2-360° BEACONS OR APPROVED MINI-BAR LIGHT

STRIPING VEHICLE WITH 4 HIGH INTENSITY FLASHING LIGHTS MOUNTED ON REAR AND 2-360° BEACONS OR APPROVED MINI-BAR LIGHT

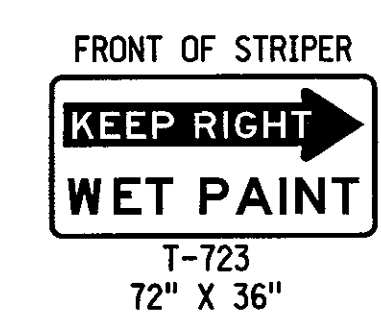
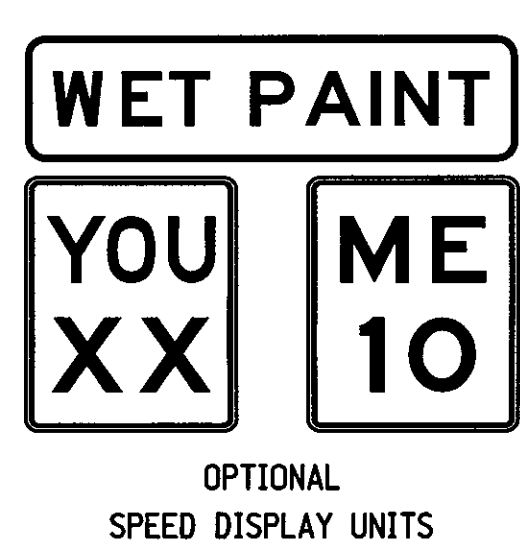
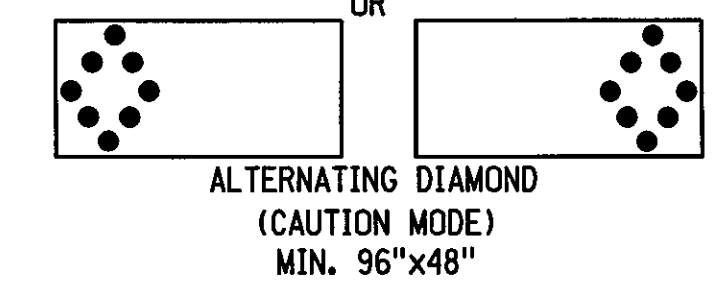
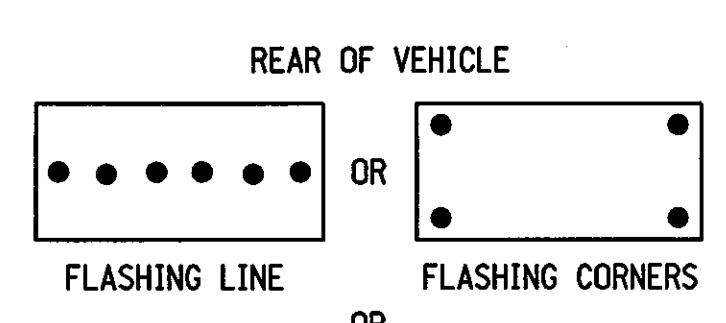

SINGLE STROBE LIGHT ON FRONT OF STRIPER
 REAR OF STRIPER ARROW PANEL

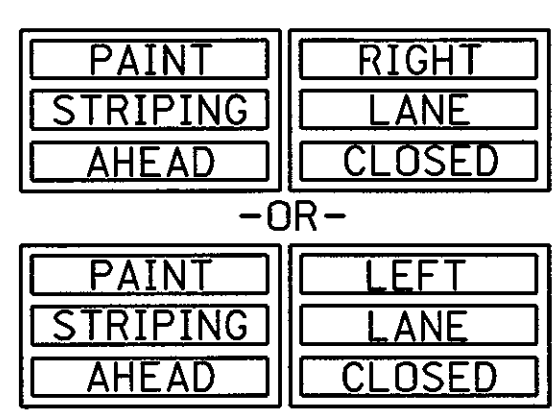
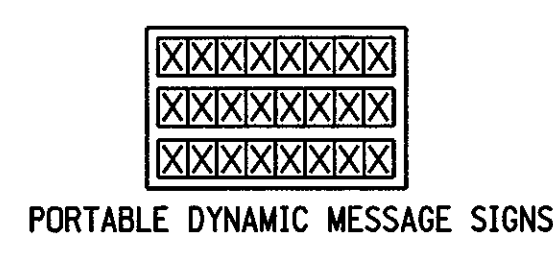
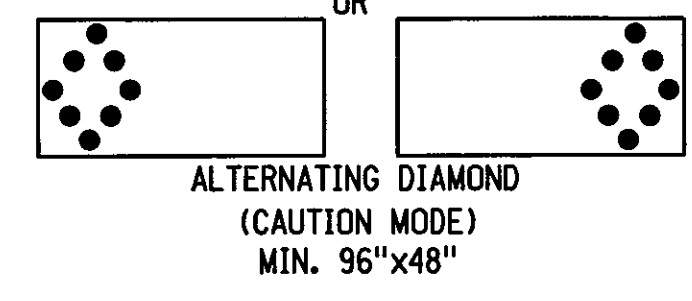
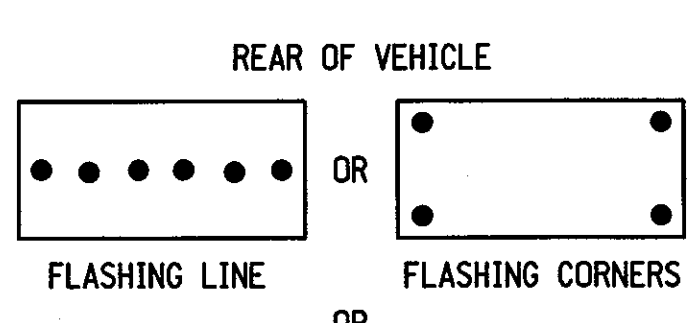

TWO MESSAGES (1.6 - 2.0 SECONDS PER MESSAGE)

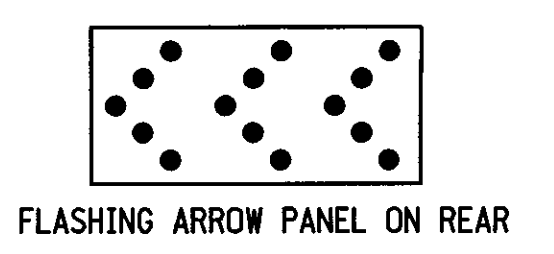
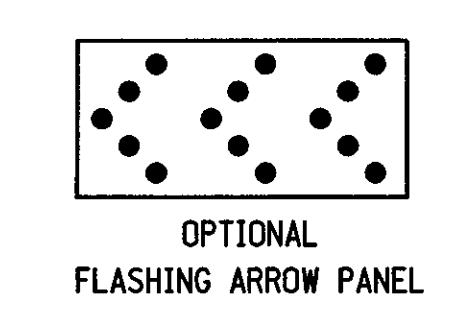
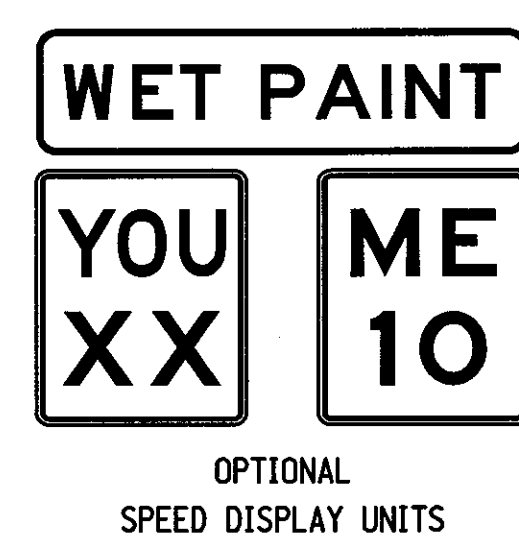
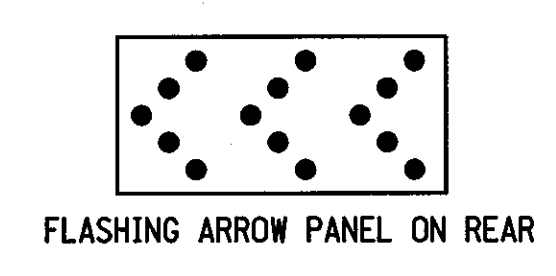

TRUCK MOUNTED ATTENUATOR SYSTEM:

- THE CONTACTOR SHALL FURNISH A FEDERALLY APPROVED TRUCK MOUNTED ATTENUATOR SYSTEM, MOUNTED ON A MINIMUM 16,000 POUND TRUCK. THE TRUCK SHALL BE EQUIPPED WITH 60" X 30" FLASHING ARROW PANEL, SECURELY MOUNTED ON THE TRUCK. THE TMA SYSTEM SHALL BE LOCATED IN THE FIELD AS REQUIRED BY THE MANUFACTURER. A COMPLETE SET OF REPLACEMENT MODULES SHALL BE AVAILABLE NEAR THE PROJECT SITE IN THE EVENT OF DAMAGE TO THE INSTALLED TMA. DAMAGED TMA'S SHALL BE REMOVED FROM THE ROADWAY AND PROJECT WORK STOPPED UNTIL REPAIRS TO THE UNIT HAVE BEEN COMPLETED.
- THE TRUCK MOUNTED ATTENUATOR SHALL BE AN NCHRP 350 OR MASH TEST LEVEL 3 APPROVED TMA FOR 100 KM PER HOUR (60 MPH).
- THE TRUCK SHALL BE A 16,000 TO 35,000 POUND (GVW) VEHICLE AS REQUIRED BY THE TMA MANUFACTURER.
- THE FLASHING ARROW PANEL SHALL BE SECURELY MOUNTED AS HIGH AS PRACTICABLE ON THE VEHICLE. THE ARROW PANEL SHALL NOT COME LOOSE UPON IMPACT TO THE TMA.

RURAL MULTI-LANE NOTES:

- WHEN WORKING ON INSIDE (LEFT) LANES VEHICLES SHALL MOVE TO SIMILAR POSITIONS IN THAT LANE.
- WARNING VEHICLE WILL REMAIN ON RIGHT SHOULDER WHEN AN 8' OR WIDER PAVED INSIDE (LEFT) SHOULDER DOES NOT EXIST.
- REAR VEHICLE WITH TMA SHALL NOT BE SUPPLY VEHICLE UNLESS PAINT IS UNLOADED.

GENERAL NOTES:

- REAR VEHICLE SHALL BE PLACED IN ADVANCE OF HORIZONTAL OR VERTICAL CURVES TO PROVIDE ADVANCE WARNING FOR WORK OPERATIONS HIDDEN BY CURVES.
- VEHICLE SPACING MAY VARY DEPENDING ON RATE OF APPLICATION, SPEED, AND DRYING TIME.
- WHEN OPTIONAL CB ALERT WARNING RADIOS ARE USED THE TRANSMITTER MUST REMAIN WITH ONE OF THE VEHICLES IN THE STRIPING TRAIN.

RURAL TWO-LANE NOTES:

- CAUTION MODE ON STRIPING UNIT AND REAR VEHICLE SHALL BE ALTERNATING DIAMOND OR THE FLASHING 4 CORNER LIGHTS IF THE DIAMOND MODE IS NOT AVAILABLE.

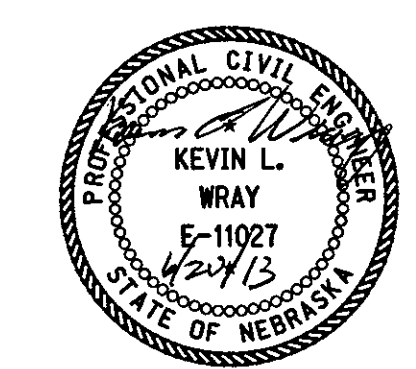

NEBRASKA DEPARTMENT OF ROADS TRAFFIC ENGINEERING DIVISION			
TRAFFIC CONTROL PLAN			
DESIGNED	TJF	VEHICLE SIGNING FOR	
REVIEWED		PAINT STRIPING	
APPROVED	DATE DRAWN	TRAFFIC ENGINEER	DATE
	12/12		

User: DOR23027
 Date: 20-JUN-2013 10:26

File: wetpaint r1.dgn
 Scale: 1:100

2 LANE ROADWAYS

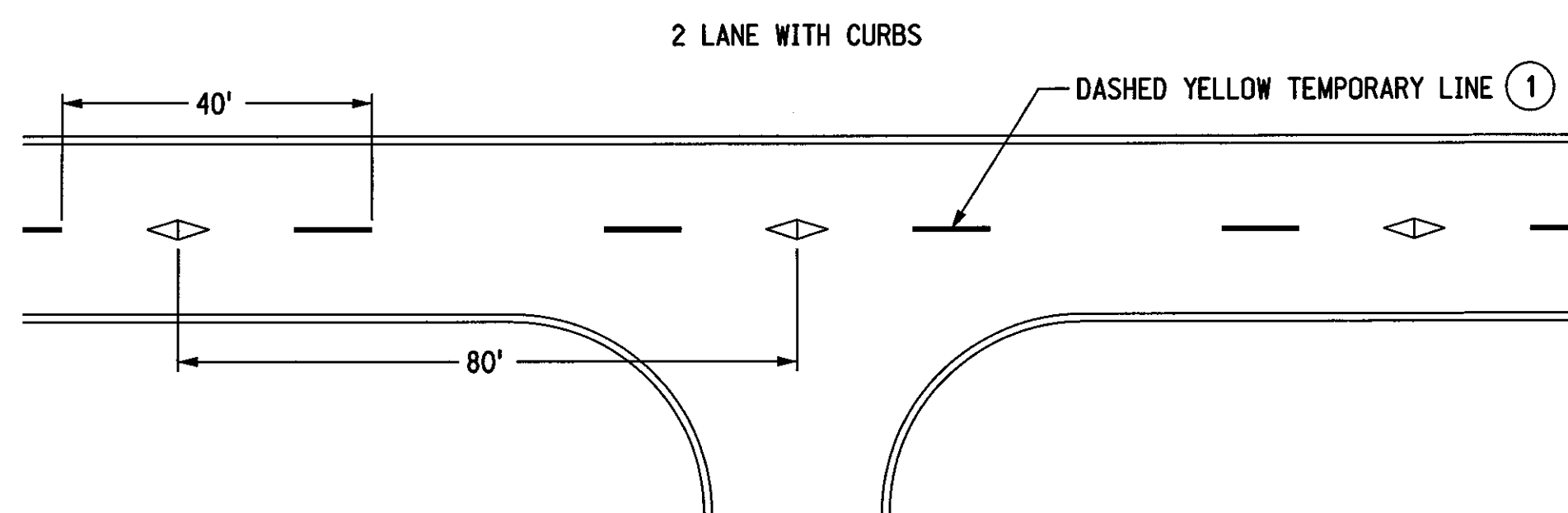

2 LANE EARTH SHOULDERS

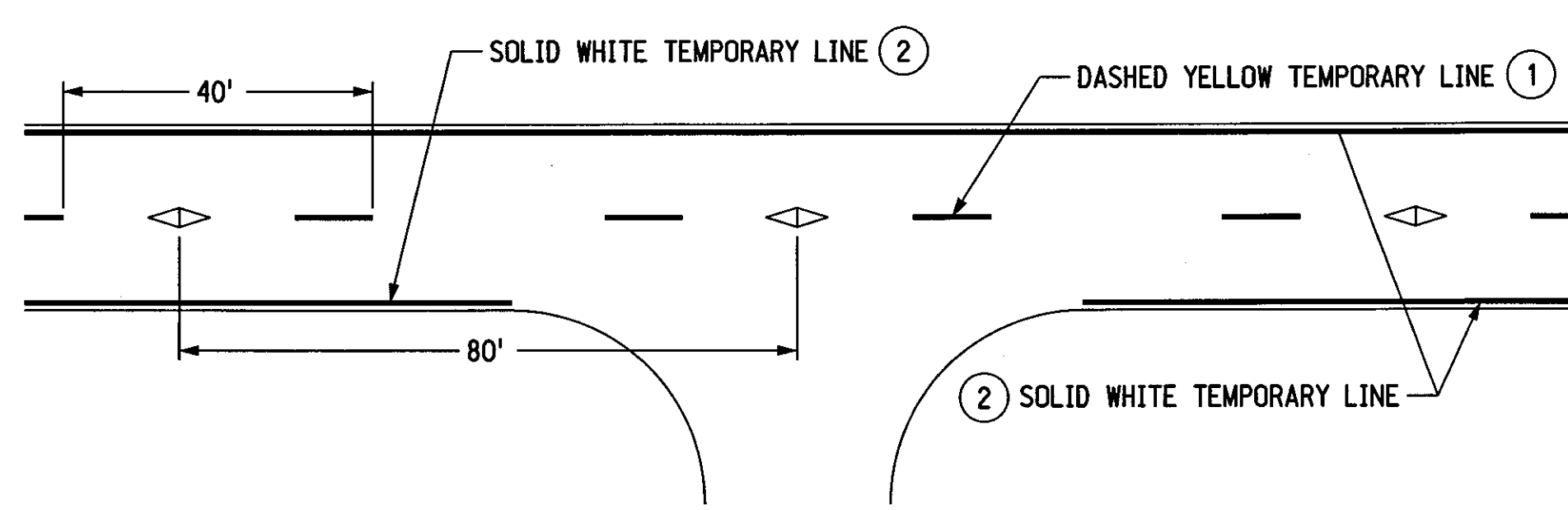

2 LANE SURFACED SHOULDERS

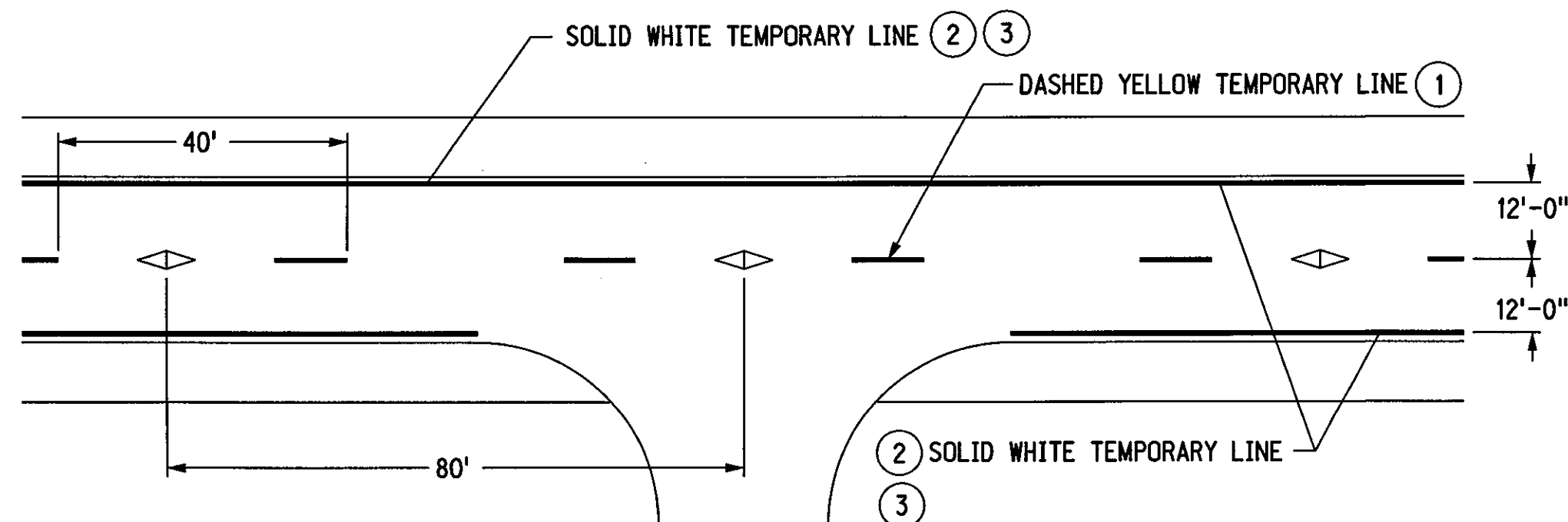

4 LANE ROADWAYS

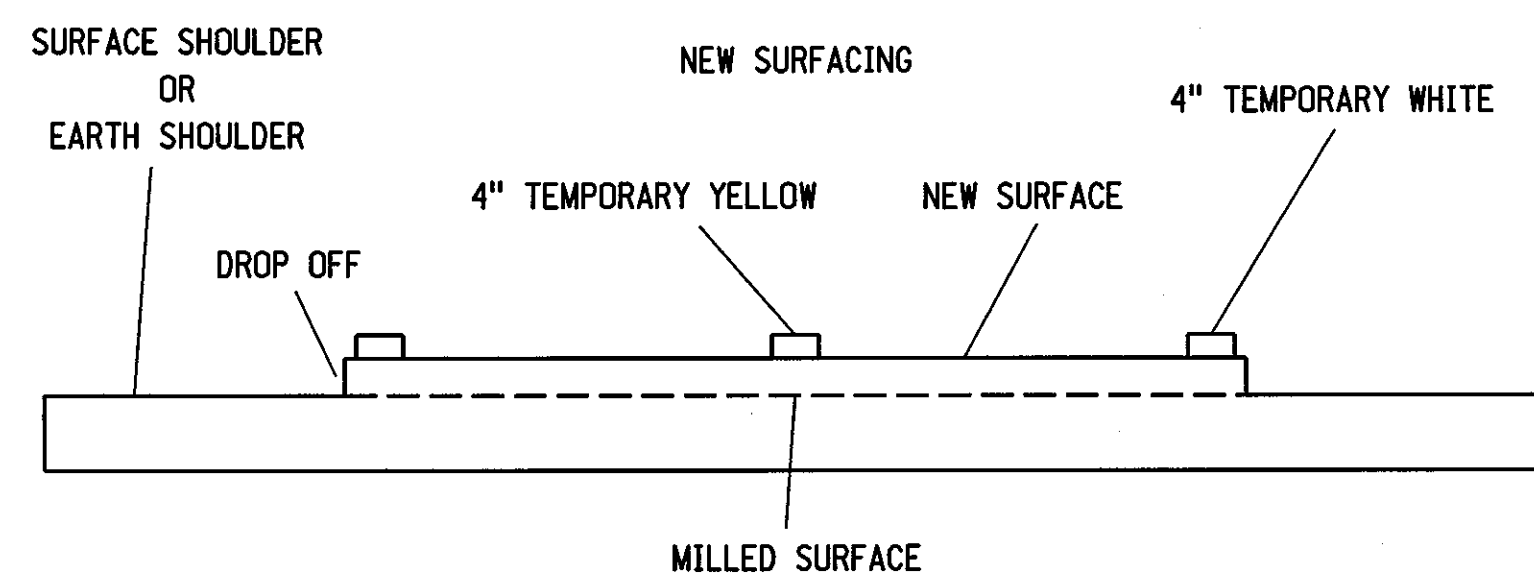
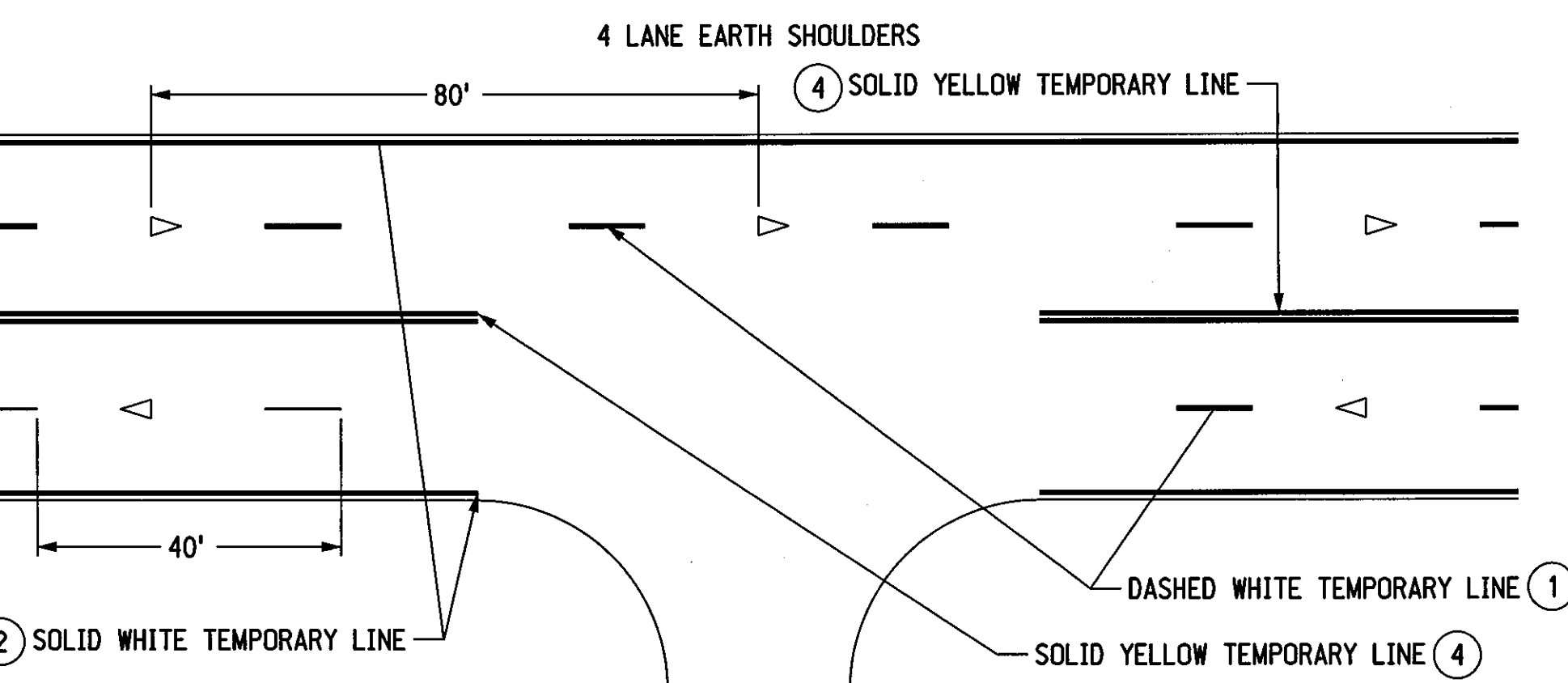
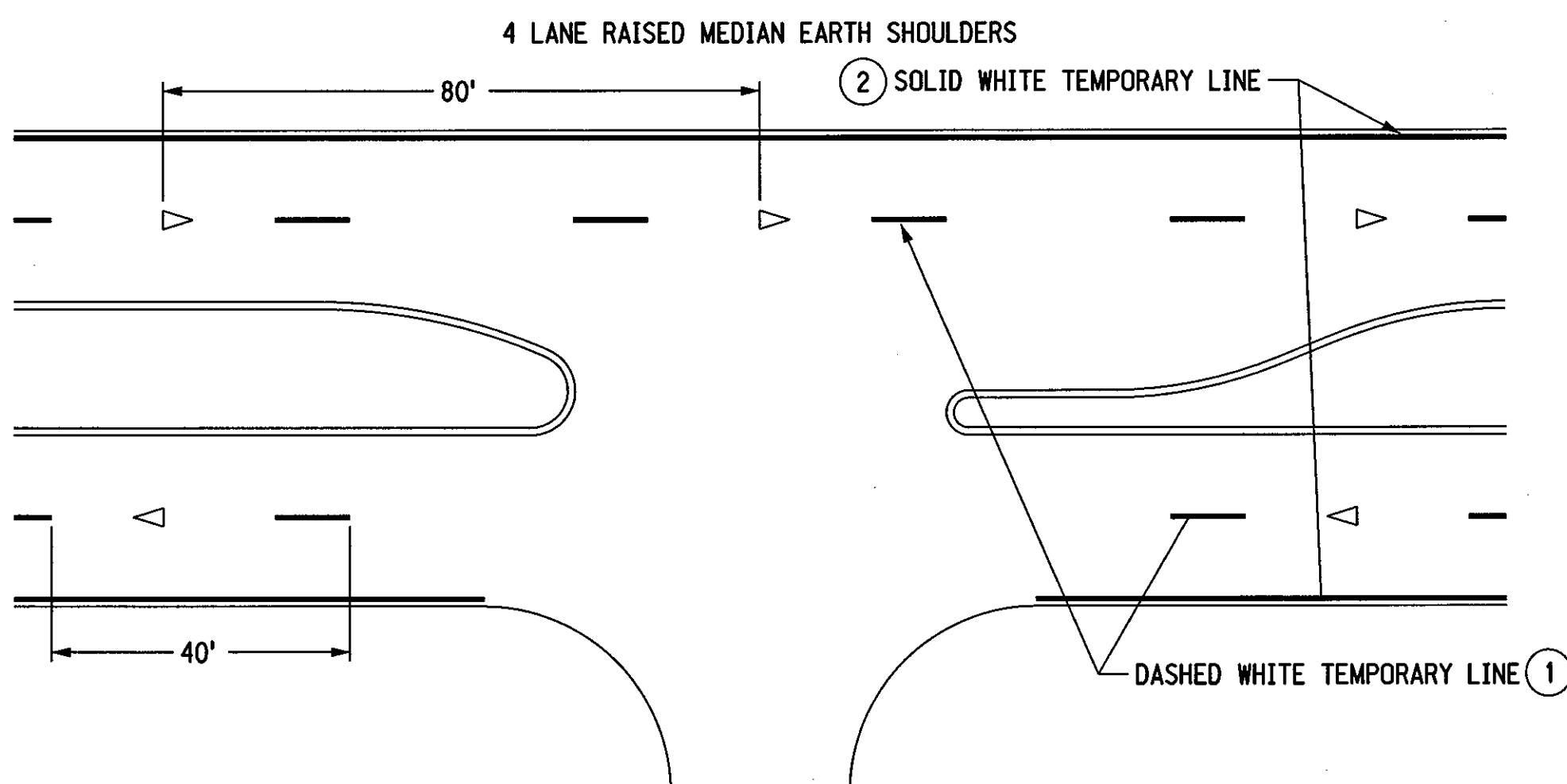

4 LANE RAISED MEDIAN WITH CURBS

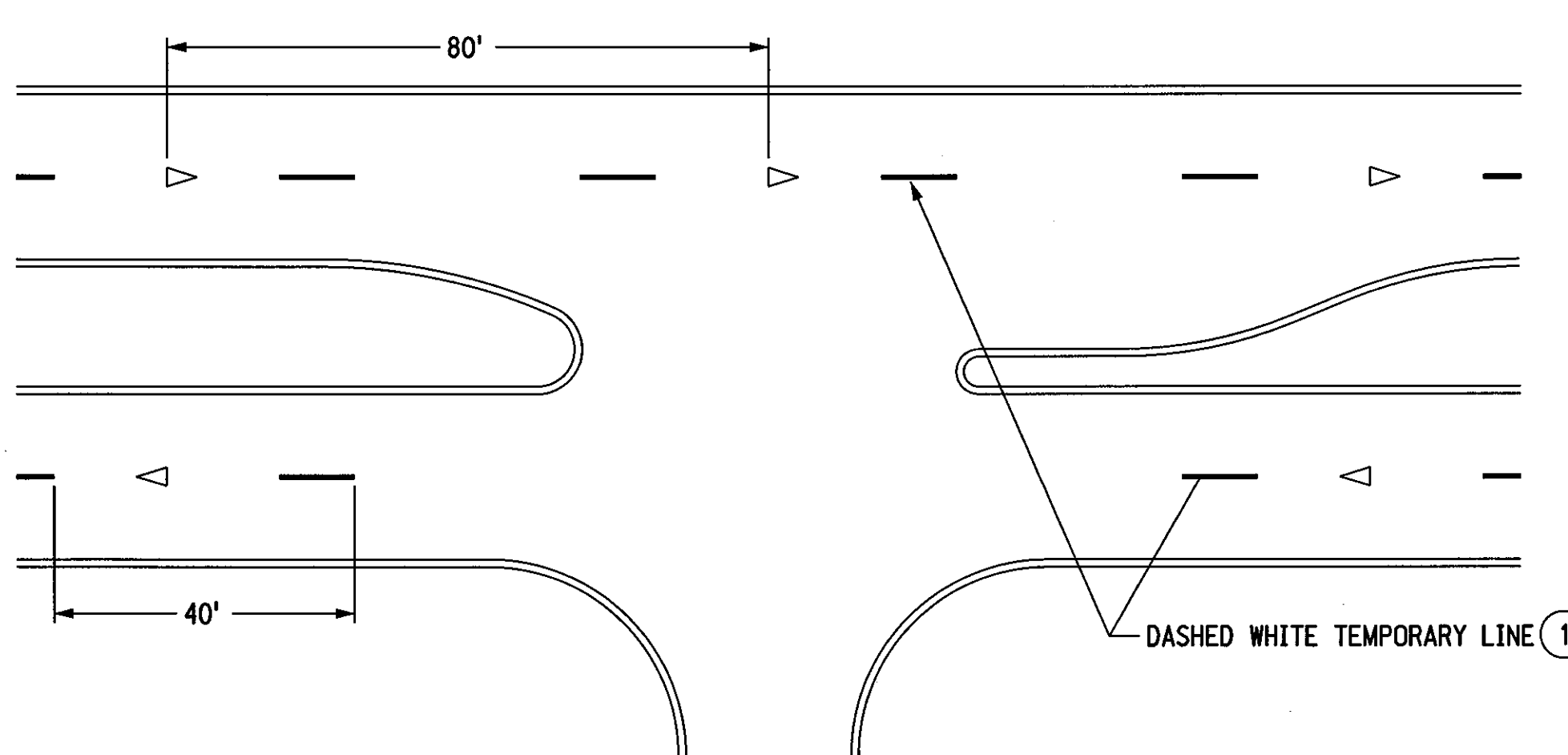

FREEWAY/RURAL EXPRESSWAY

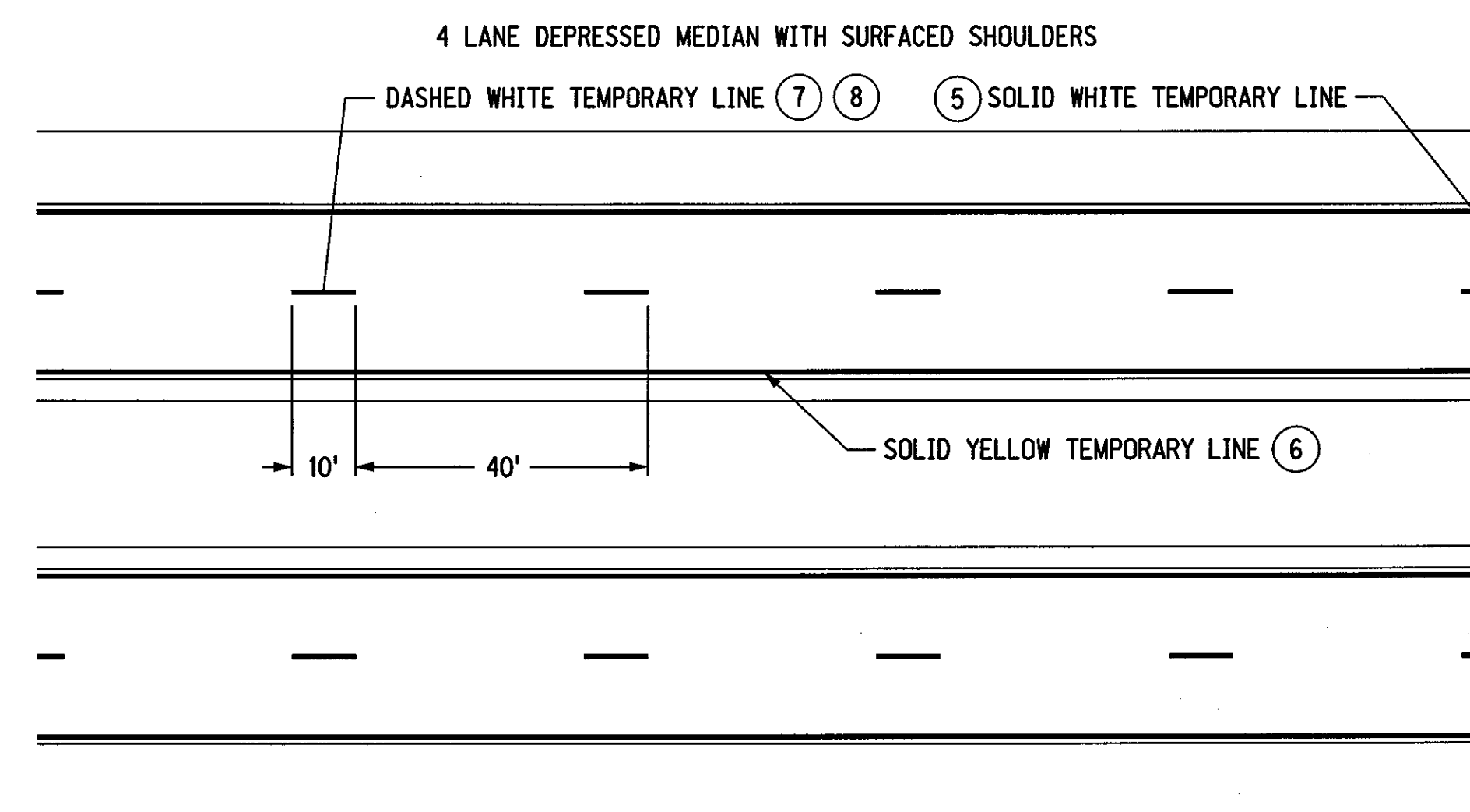

NOTES

- ① LOWER LAYERS: TEMPORARY DASHED LINE SHALL BE 4" X 10' PAINTED LINE AT 40' INTERVALS OR 4" X 4' TYPE I TAPE LINE AT 40' INTERVALS. TAPE OR PAINT WILL BE SUPPLEMENTED WITH AN OVERLAY MARKER EVERY 80 FEET.
 - OVERLAY MARKERS ARE NOT REQUIRED ON MILLED SURFACES, HYDRATED LIME SURFACES AND STABILIZED SURFACES.
- TOP LAYER:
 - BROKEN LINE MARKINGS
 - INSTALL 4" X 4' TAPE AT 40' INTERVALS SUPPLEMENTED WITH AN OVERLAY MARKER EVERY 80 FEET.
 - OR USE NO TAPE, BUT INSTALL 2 RAISED PAVEMENT MARKERS SPACED 5' APART AT 40' INTERVALS.
 - SOLID LINE MARKINGS
 - 4" WIDE PAINTED LINE OR PAVEMENT MARKING TAPE. RAISED PAVEMENT MARKERS MAY BE USED IN LIEU OF PAINT OR TAPE, INSTALLED AT 10' INTERVALS.
- ARMOR COATS
FOG SEALS: 2 OVERLAY MARKERS 5' APART, PER 40 FOOT CYCLE (NO PAINT OR TAPE).
- ② TEMPORARY SOLID LINE SHALL BE 4" WIDE PAINTED LINE.
- ③ EDGE LINE SHALL BE PLACED SO THAT THE OUTSIDE EDGE OF PAINT IS THE REQUIRED DISTANCE FROM CENTERLINE ON THE TOP LIFT
- ④ TEMPORARY CENTERLINE SHALL BE TWO 4" PAINTED LINES SPACED 4" APART, CENTERED ABOUT THE JOINT LINE.
- ⑤ EDGE LINE SHALL BE 4" PAINTED LINE. PLACED TO THE LEFT OF JOINT LINE.
- ⑥ ALL LAYERS: EDGE LINE SHALL BE PLACED 12'-0" FROM THE CENTER JOINT LINE. (RIGHT OF SHOULDER JOINT LINE WHEN APPLICABLE)
- ⑦ MILLED SURFACE OR LOWER LIFTS: THE TEMPORARY WHITE DASH LINE SHALL BE 4" X 10' MINIMUM PAINTED LINE AT 40' INTERVALS, PLACED TO THE LEFT OF THE JOINT LINE.
- ⑧ TOP LIFT: THE TEMPORARY WHITE DASH LINE SHALL BE 4" IN WIDTH X MINIMUM 8' TO MAXIMUM 10' LENGTH, PLACED 2" TO THE LEFT OF THE JOINT LINE. THE INTERVAL (CYCLE) SHALL BE 40' ± 2" TO ALLOW FOR THE PERMANENT PAVEMENT MARKING.
- ⑨ ALL TEMPORARY PAVEMENT MARKING THAT WILL BE COVERED BY PERMANENT PAVEMENT MARKING SHALL COMPLY WITH THE ALIGNMENT AND LOCATION REQUIREMENTS OF THE FINAL PAVEMENT MARKING MATERIAL. TEMPORARY PAVEMENT MARKINGS THAT ARE NOT COVERED BY THE PERMANENT MARKINGS SHALL BE REMOVED AT THE CONTRACTOR'S EXPENSE.

ROADWAY WIDTH	SHOULDER TYPE	DISTANCE FROM C OF ROADWAY TO OUTSIDE EDGE OF PAVEMENT
LESS THAN 24'	SURFACED	EDGE OF LANE
LESS THAN 24'	EARTH	PAVEMENT EDGE
24'	EARTH	PAVEMENT EDGE
24'	SURFACED	12'-0" *
24' TO 28'	EARTH	12'-0" *

* SEE NOTE 3

CENTERLINE MARKING SHALL BE PLACED ON THE "SOUTH" SIDE OF THE CENTER JOINT ON EAST-WEST ROADS AND ON THE "EAST" SIDE OF THE CENTER JOINT ON NORTH-SOUTH ROADS

LEGEND

- ◁ OVERLAY MARKER
- ◁ BIDIRECTIONAL OVERLAY MARKER

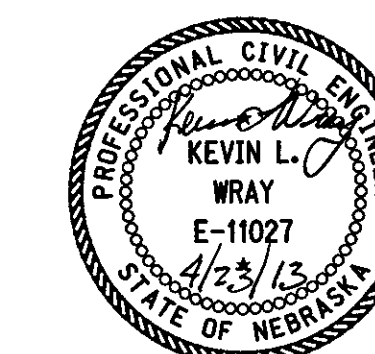

NEBRASKA DEPARTMENT OF ROADS TRAFFIC ENGINEERING DIVISION

TYPICAL PAVEMENT MARKING

DESIGNED	DV	TEMPORARY PAVEMENT MARKING PLAN	1/1
REVIEWED	MAN	TRAFFIC ENGINEER	DATE
DATE DRAWN	8/06		

2 LANE ROADWAYS WITH CURBS

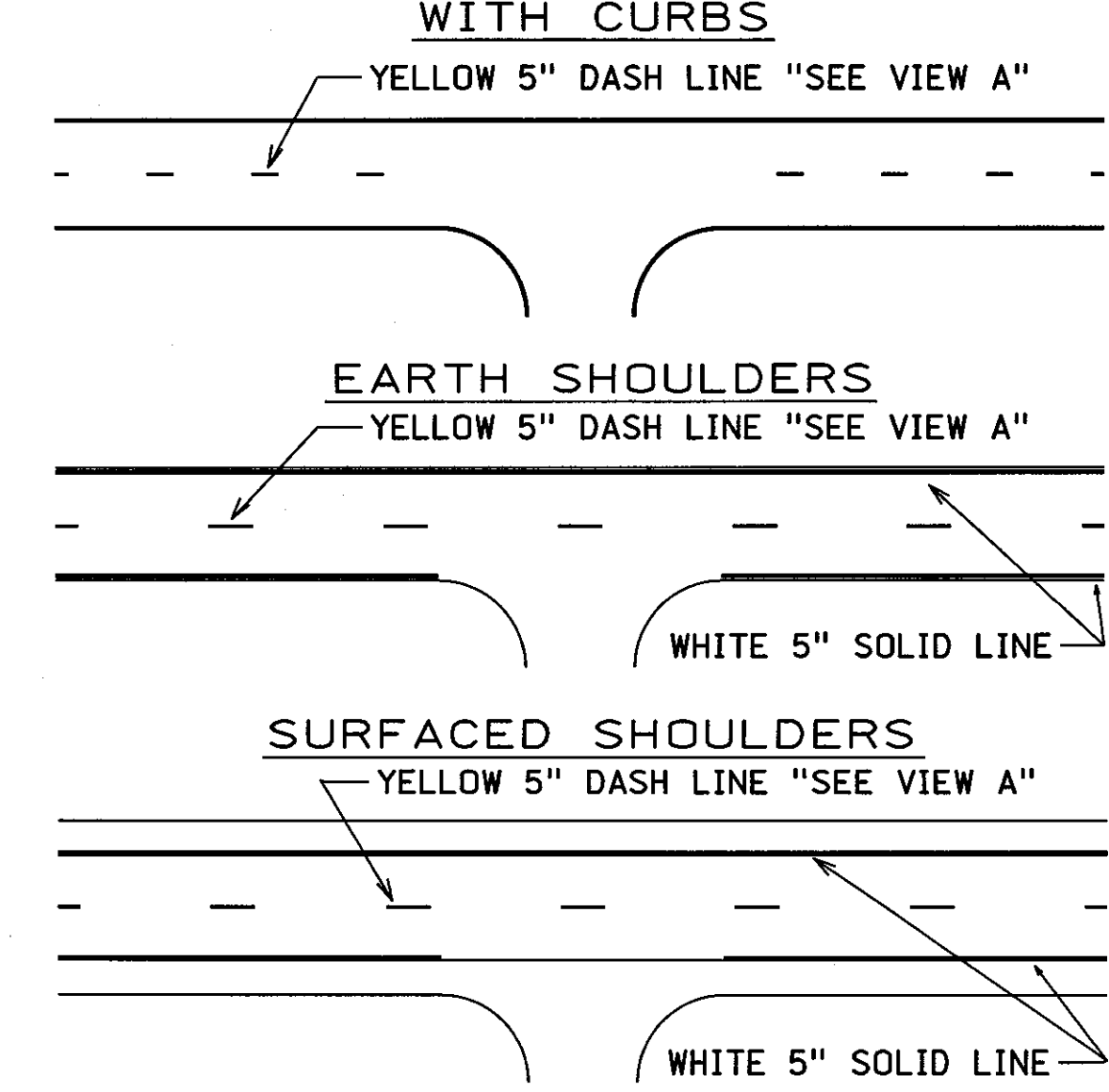

4 LANE DIVIDED ROADWAY

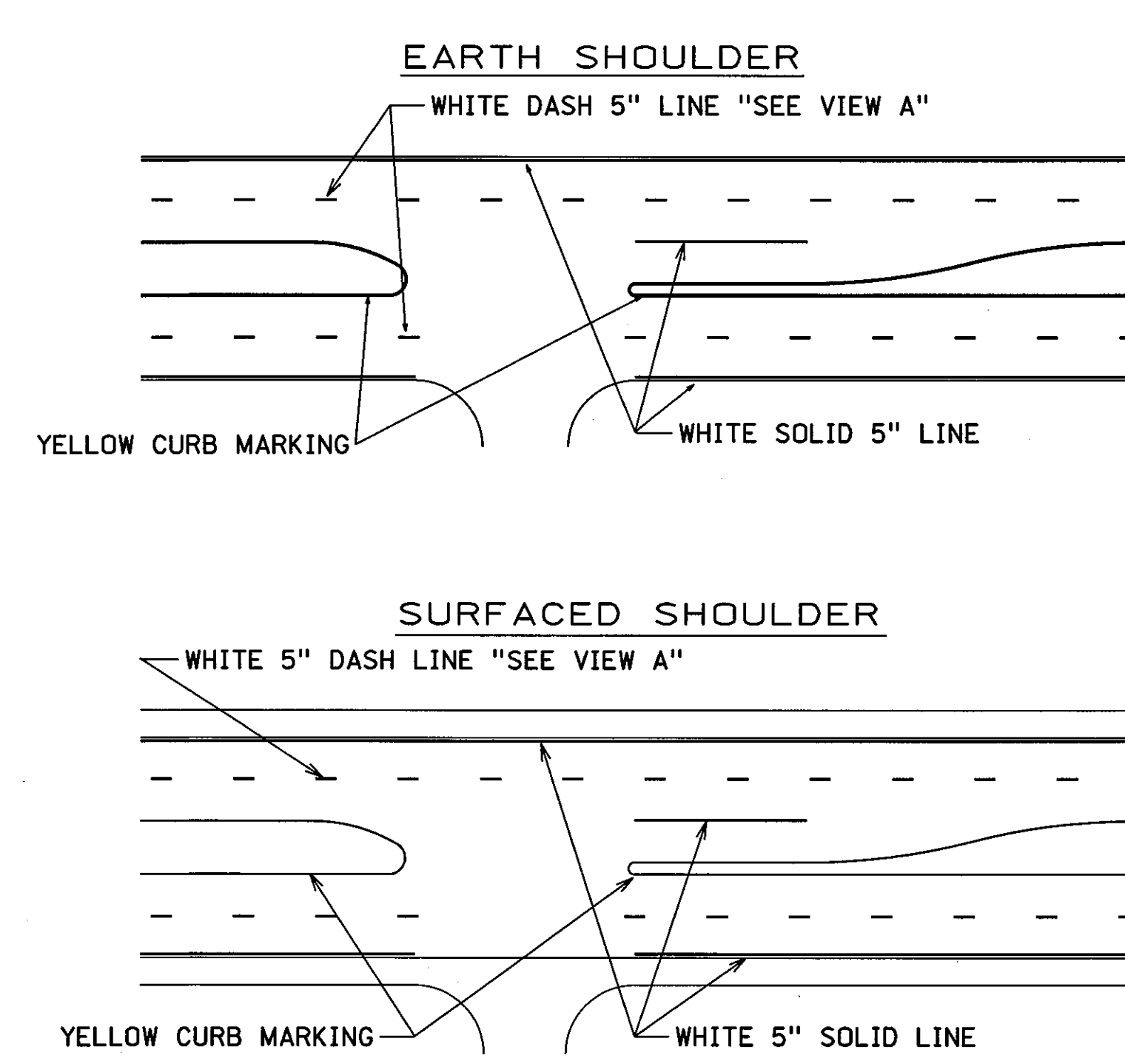

GORE MARKINGS (NON-FREEWAY)

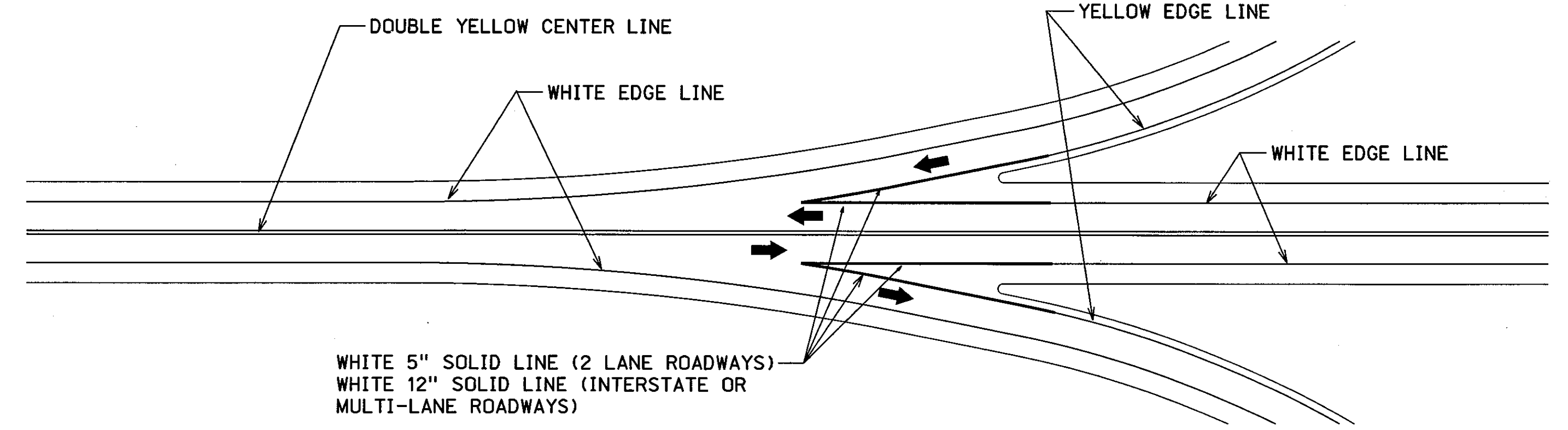

ISLAND MARKING

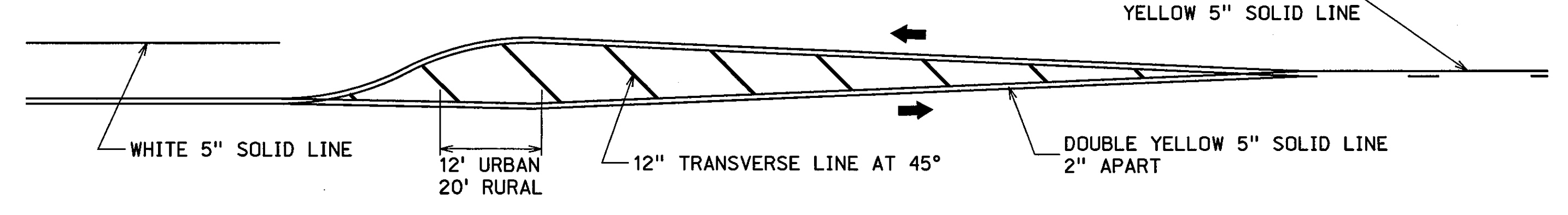

2-LANE ROADWAY REQUIRED LOCATION FOR EDGE LINES		
ROADWAY WIDTH	SHOULDER TYPE	DISTANCE FROM CENTERLINE OF ROADWAY TO OUTSIDE EDGE OF PAVEMENT EDGELINE
LESS THAN 24 FT	SURFACED	12 FT 0 IN
LESS THAN 24 FT	EARTH	PAVEMENT EDGE
24 FT	EARTH	PAVEMENT EDGE
24 FT	SURFACED	12 FT 0 IN
GREATER THAN 24 FT	EARTH	12 FT 0 IN

CENTERLINE MARKING SHALL BE PLACED ON THE "SOUTH" SIDE OF THE CENTER JOINT ON EAST-WEST ROADS AND ON THE "EAST" SIDE OF THE CENTER JOINT ON NORTH-SOUTH ROADS

PASSING LANE MARKING

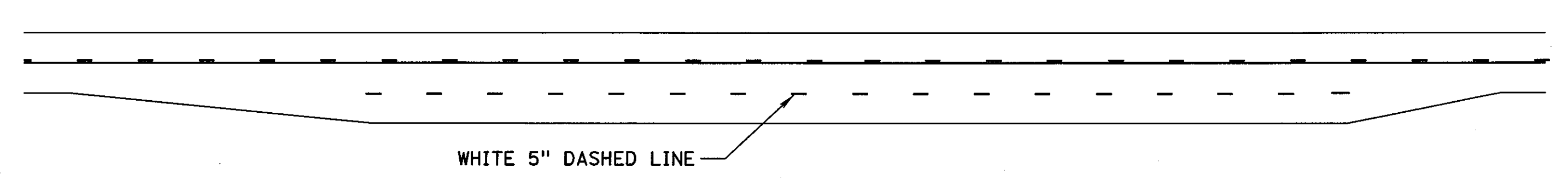

FLY-BY LANE MARKING

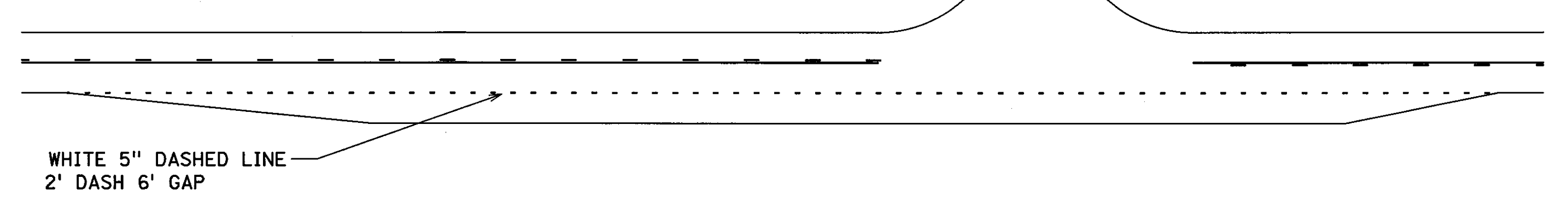

4 LANE ROADWAYS NO CURBS

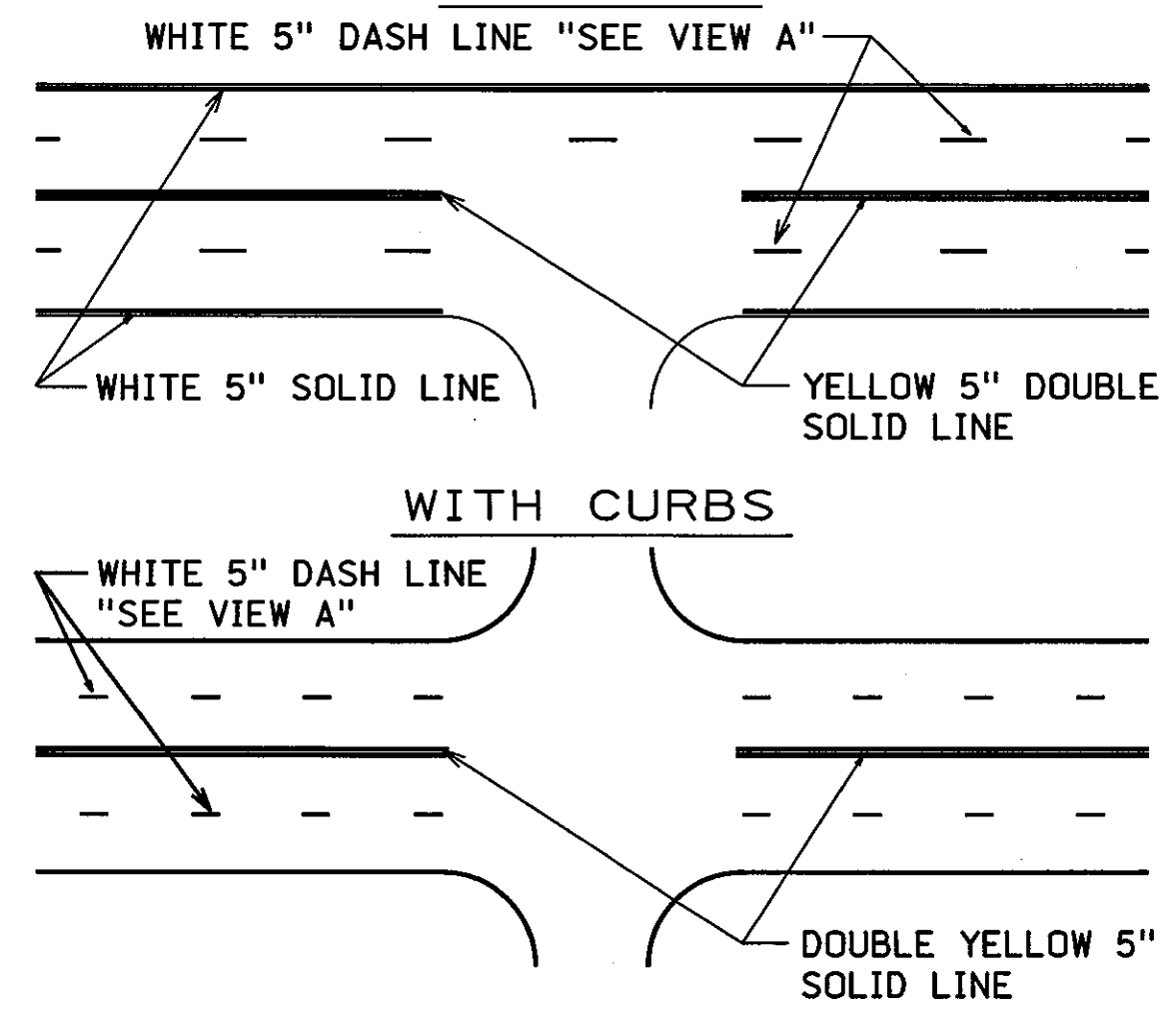

WITH CURBS

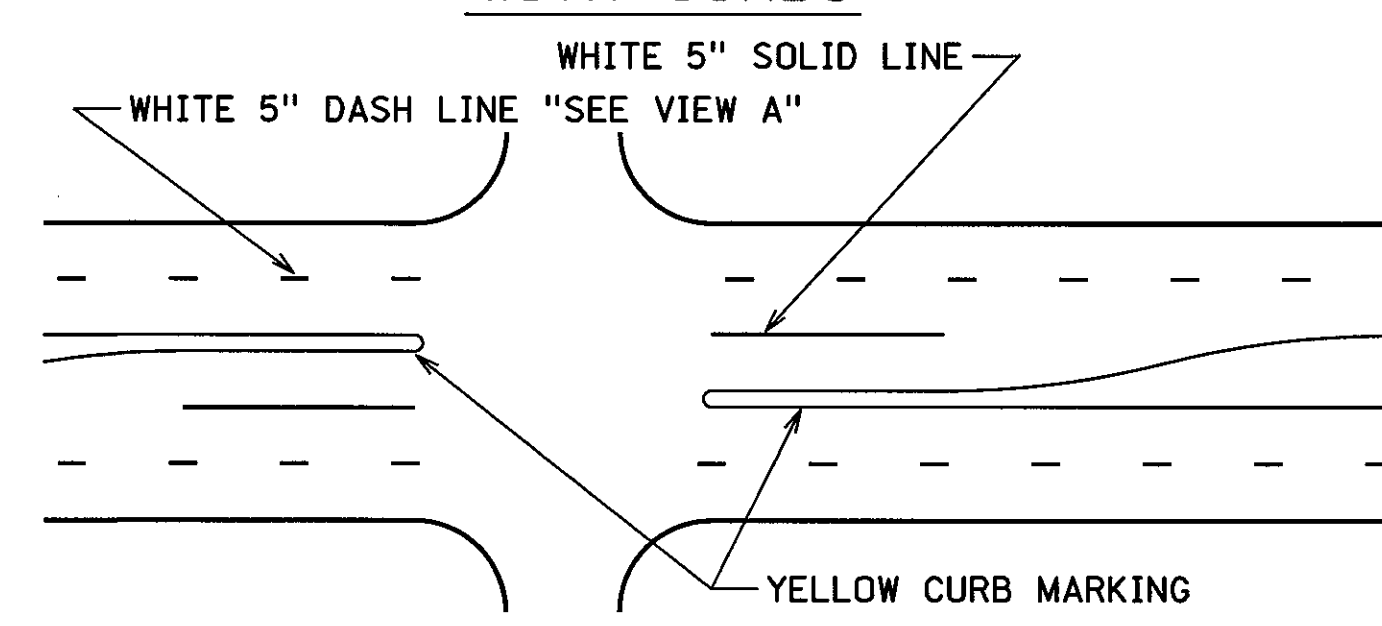

DEPRESSED MEDIAN

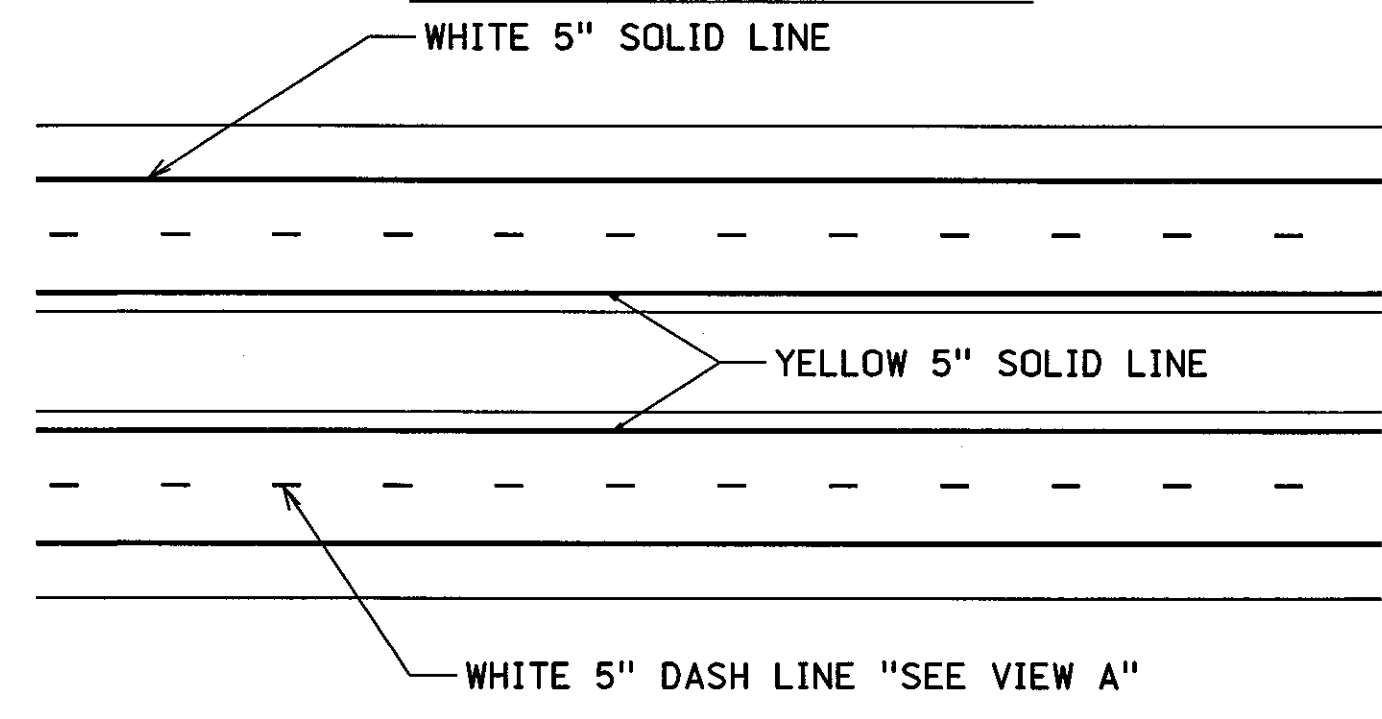

TYPICAL NO PASSING ZONE MARKINGS

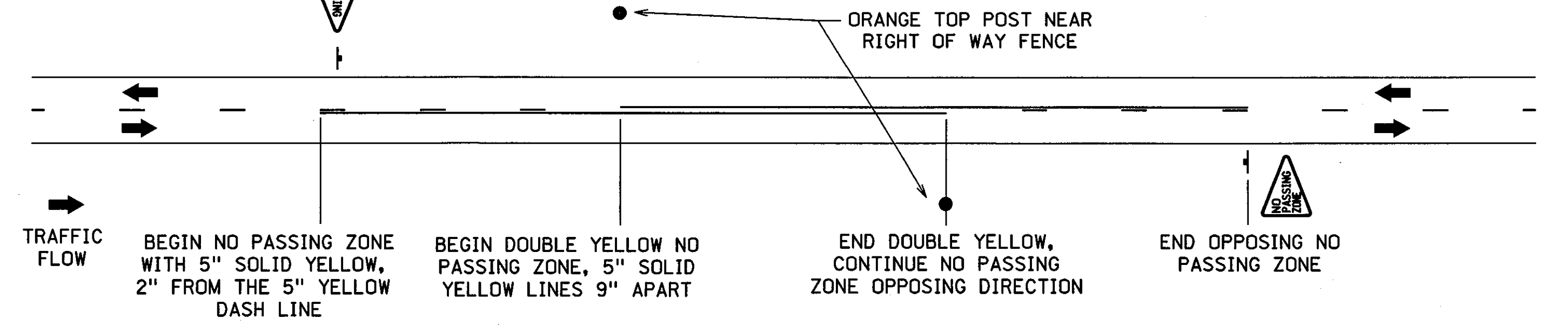

3 OR 5 LANE WITH COMMON LEFT TURN LANE

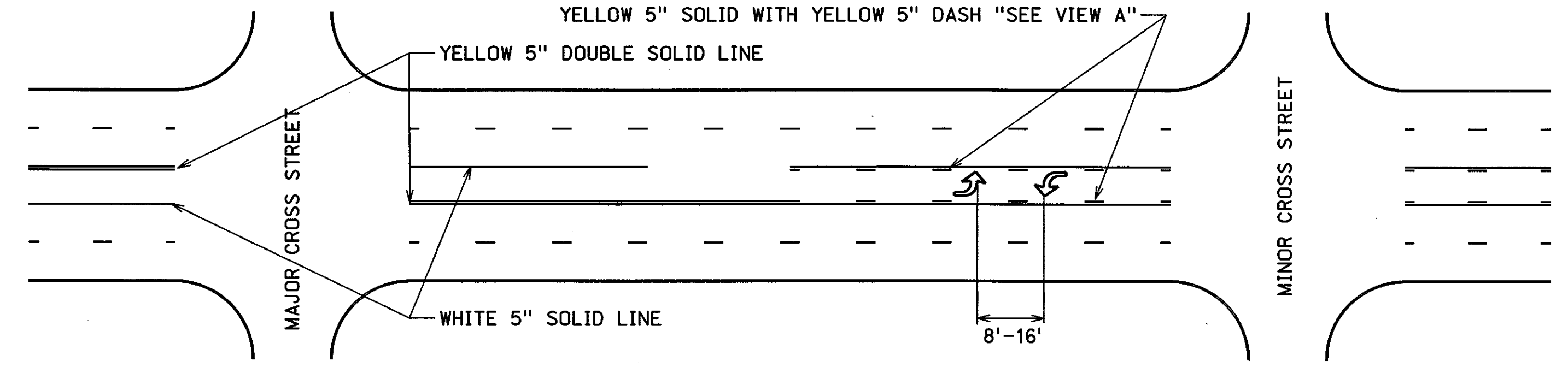

VIEW A

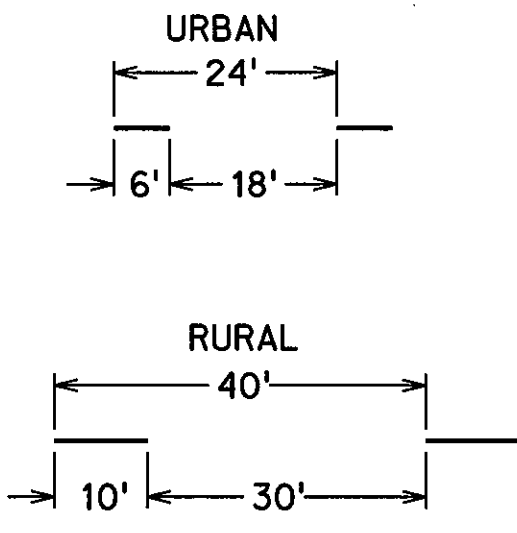

PERMANENT PAVEMENT MARKINGS INSTALLED IN GROOVES

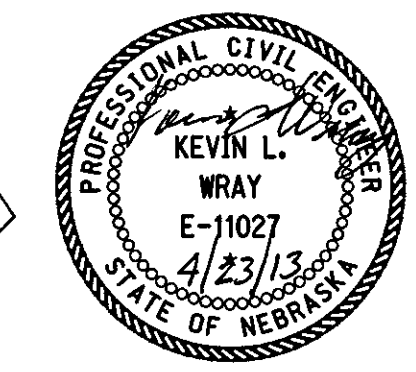
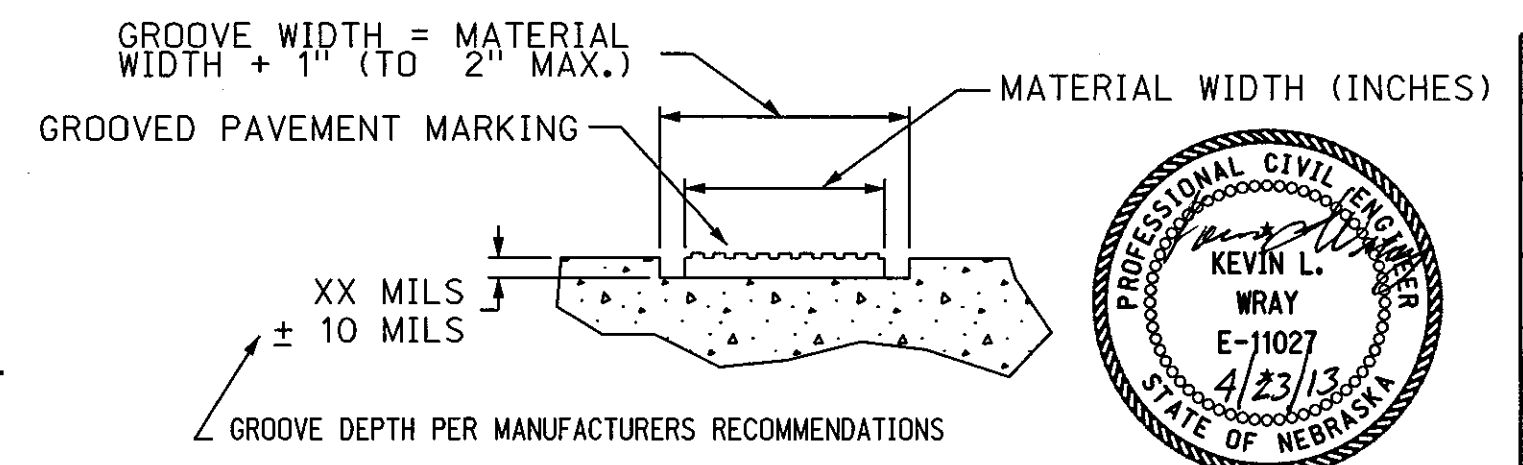

NEBRASKA DEPARTMENT OF ROADS TRAFFIC ENGINEERING DIVISION			
TYPICAL PAVEMENT MARKING PLAN			
DESIGNED	TJF	5" PAVEMENT MARKING	
REVIEWED			1/1
APPROVED	DATE DRAWN	TRAFFIC ENGINEER	DATE
	12/12		