

INDEX OF SHEETS

SHEET NO.	
1	TITLE PAGE
2-T	TYPICAL CROSS SECTIONS
2-S	SUMMARY OF QUANTITIES
3	TEMPORARY PAVEMENT MARKING PLAN
4	TYPICAL PAVEMENT MARKING PLAN--5" PAVEMENT MARKING
5	PAVEMENT MARKING PLAN--VEHICLE SIGNING FOR PAINT STRIPING

STANDARD PLANS

920-R6	(3 SHEETS) TRAFFIC CONTROL, CONSTRUCTION AND MAINTENANCE
922-R9	(2 SHEETS) TRAFFIC CONTROL FOR ASPHALT SURFACING

STATE OF NEBRASKA
DEPARTMENT OF ROADS
PLANS FOR CONSTRUCTION
HARROP - ROSE
LOUP & ROCK COUNTIES

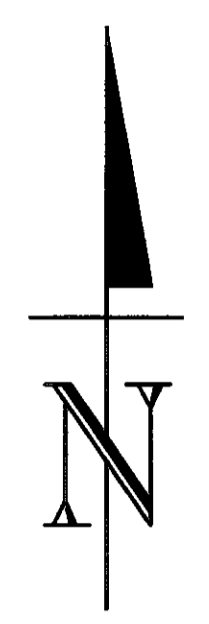

PROJECT NO.	SHEET NO.
RD-183-3(1025)	1
▲ CONTROL NO.	80959
▲ CONTROL NO.	
■ CONTROL NO.	

THE 2007 EDITION OF THE NEBRASKA STANDARD SPECIFICATIONS AND THE SPECIAL PROVISIONS APPLY TO THIS PROJECT.

THE WORK ON THIS PROJECT CONSISTS OF GROUPS

9-BITUMINOUS
▲ GROUPS <u>9</u> ARE INCLUDED IN THE LETTING OF <u>SEPTEMBER 4, 2014</u>
▲ GROUPS _____ ARE INCLUDED IN THE LETTING OF _____
■ GROUPS _____ ARE INCLUDED IN THE LETTING OF _____

DESIGN DESIGNATION

MAINTENANCE
TRAFFIC
YEAR: 2015
ADT: 650

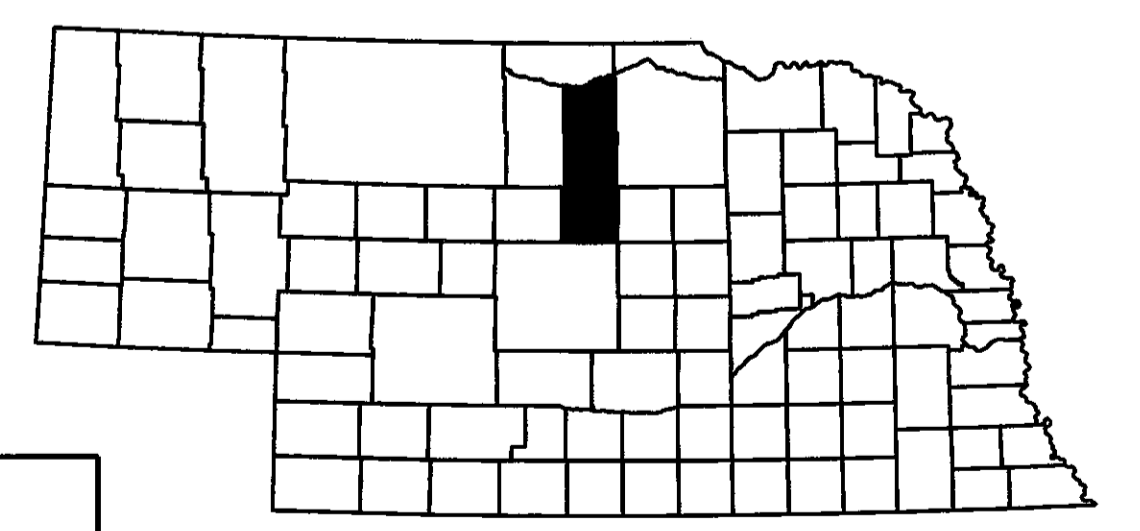
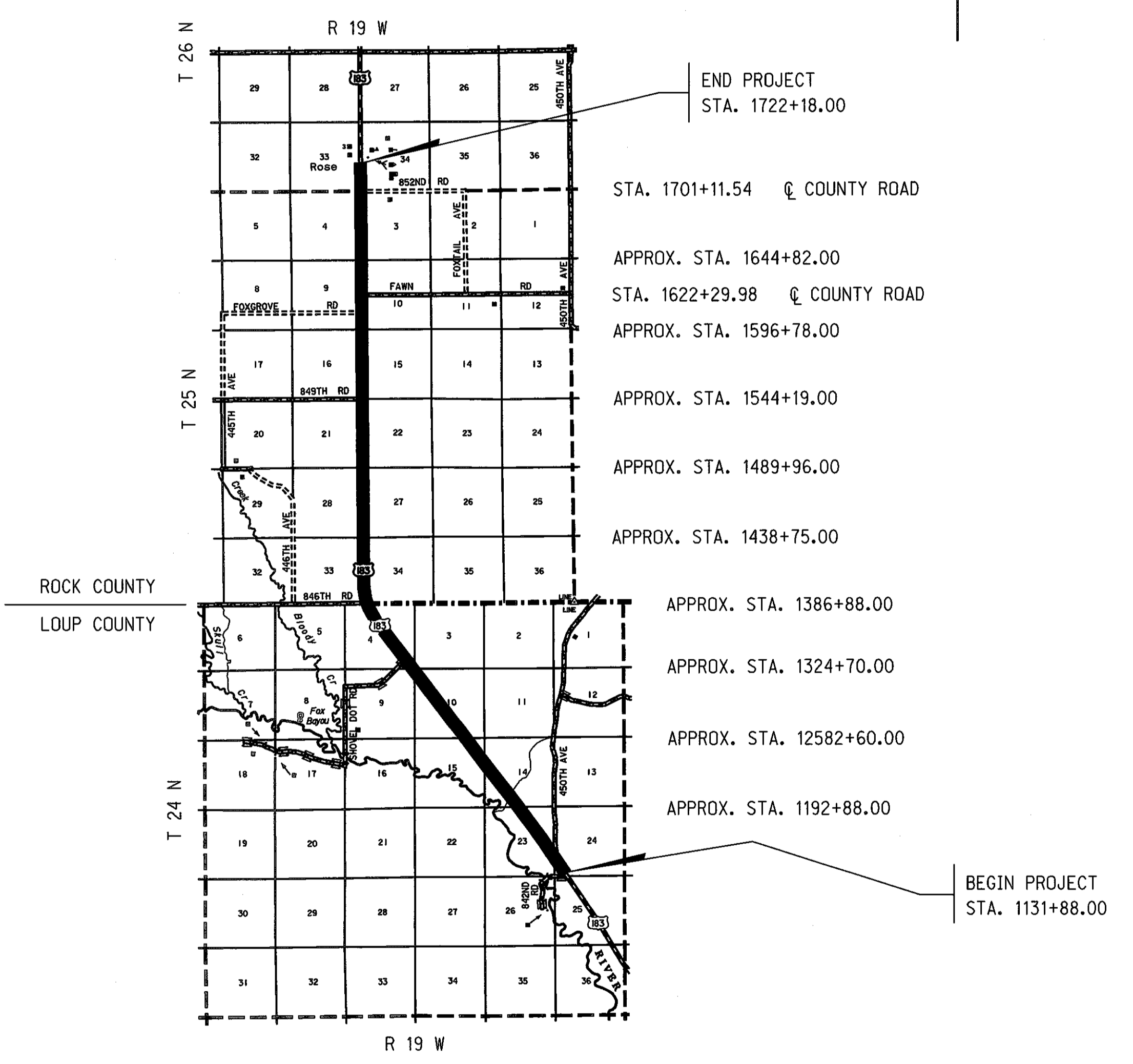

CONVENTIONAL SIGNS

FENCE R.O.W. OR WIRE	
GUARDRAIL	
TRAVELED WAY	
DIKE	
CULVERT	
POWER POLE	
TELEPHONE POLE	
MAILBOX	
RAILROAD TRACKS	
MARSH	
TREE - CONIFEROUS	
TREE - DECIDUOUS	

R.O.W. LEGEND

NEW CONTROLLED ACCESS	
PREVIOUS CONTROLLED ACCESS	
LIMITS OF CONSTRUCTION	
PREVIOUS R.O.W.	
NEW R.O.W.	
EXISTING PERMANENT EASEMENT	
TEMPORARY EASEMENT	
EXCESS TAKING	
PERMANENT EASEMENT	
EXISTING RAILROAD EASEMENT	
NEW RAILROAD PERMANENT EASEMENT	
NEW RAILROAD TEMPORARY EASEMENT	

REFERENCE POST NO. 143+41 TO REFERENCE POST NO. 154+62

EXCEPTIONS: FROM STA. _____ TO STA. _____

TOTAL NET LENGTH OF PROJECT: 59,030.00 FEET 11.180 MILES

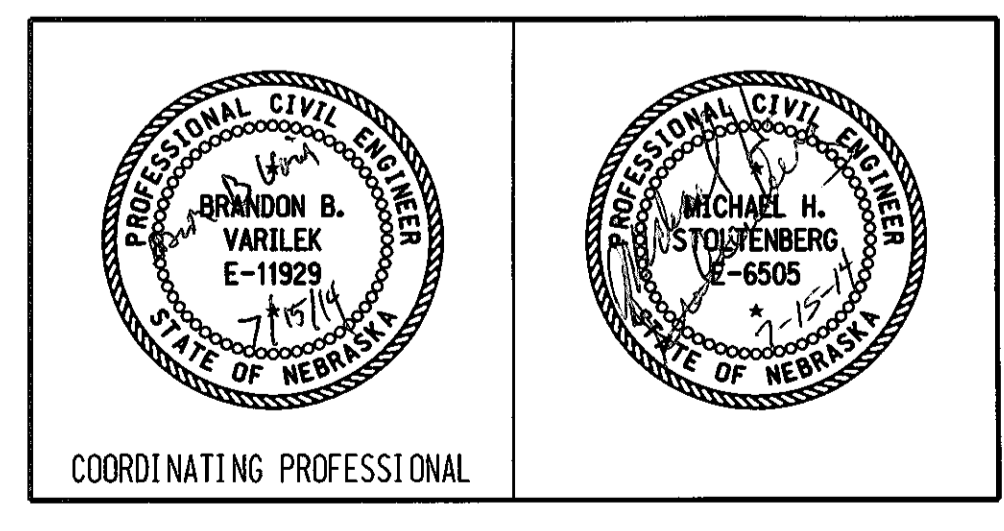

CONSTRUCTION DIVISION

File: 809590pset11e.dgn
Scale: 1:100

CONSTRUCTION DIVISION

PROJECT NO.	SHEET NO.
183-3(1025)	2-T

C.N. 80959

TYPICAL CROSS SECTIONS

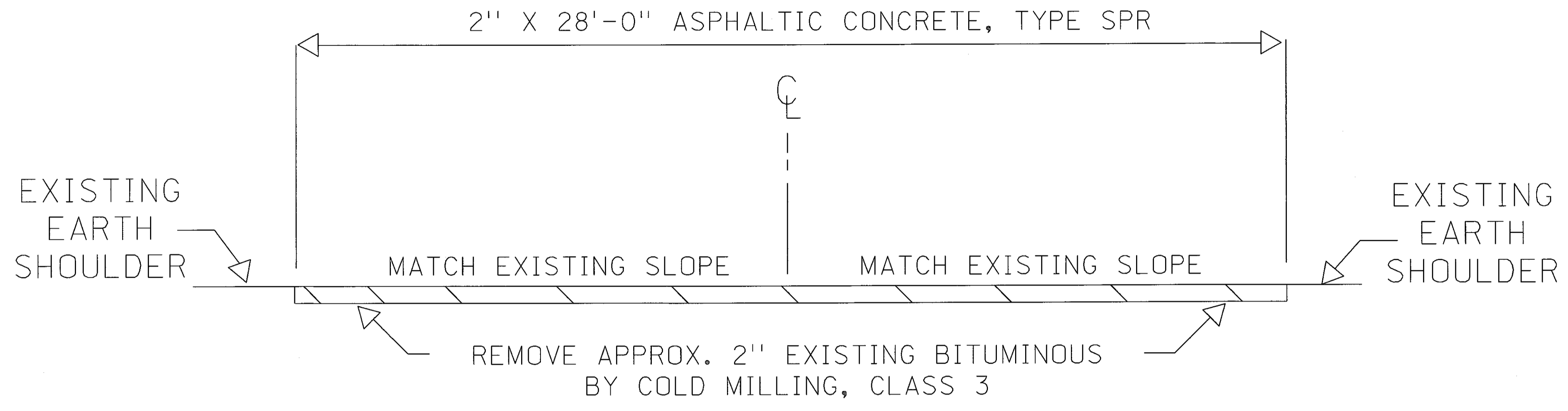

STATION TO STATION
1131+88 - 1722+18

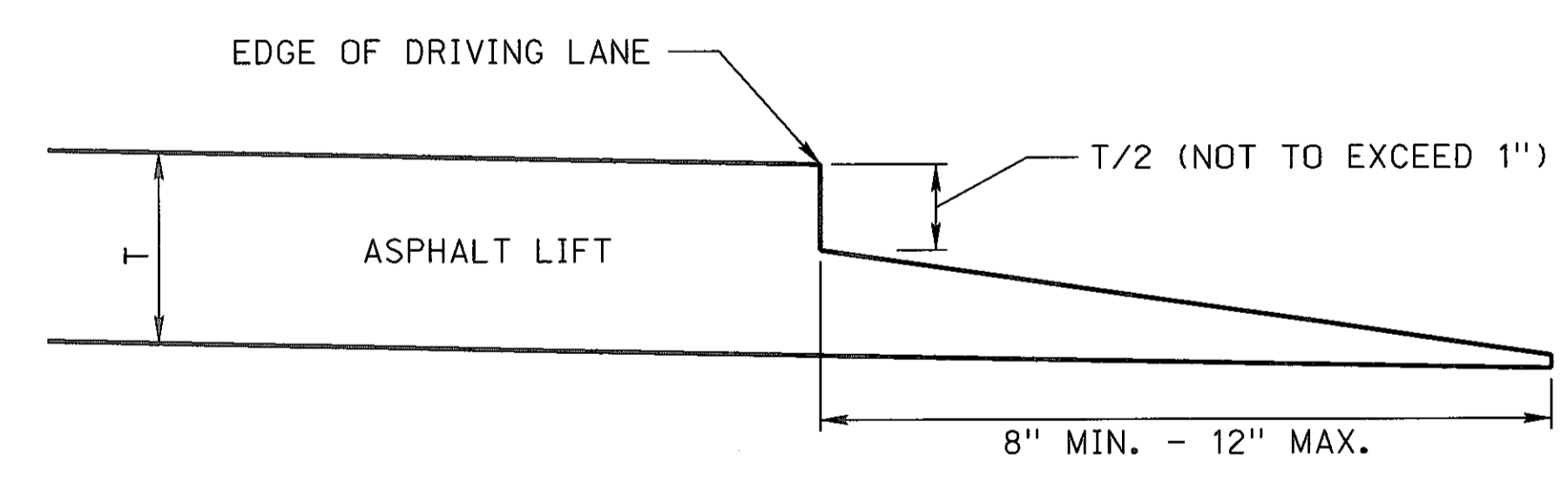

NOTCHED WEDGE JOINT
(CONSTRUCTION DETAIL)

File: 80959dps.summary.dgn
Scale: 1:100



SUMMARY OF QUANTITIES

PROJECT NO.	SHEET NO.
183-3(1025)	2-S

C.N. 80959

BITUMINOUS SURFACING ITEMS GROUP 9

ITEM	QUANTITY	UNITS
BARRICADE, TYPE II	6,875.000	BDAY
BARRICADE, TYPE III	216.000	BDAY
TEMPORARY SIGN DAY	350.000	EACH
SIGN DAY	4,633.000	EACH
OVERLAY BROKEN LINES	1,180.000	STA
OVERLAY SOLID LINES	2,360.000	STA
FLAGGING	50.000	DAY
FIELD OFFICE	1.000	EACH
MOBILIZATION	1.000	LS
HYDRATED LIME/WARM MIX ASPHALT FOR STATE MAINTENANCE PATCHING	200.000	EACH
HYDRATED LIME/WARM MIX ASPHALT	20,670.000	EACH
ASPHALTIC CONCRETE FOR STATE MAINTENANCE PATCHING, TYPE SPR	200.000	TON
ASPHALTIC CONCRETE, TYPE SPR	20,170.000	TON
PLACEMENT OF ASPHALTIC CONCRETE FOR DRIVEWAYS AND INTERSECTIONS	1,428.000	SY
ASPHALTIC CONCRETE FOR PATCHING, TYPE SPR	500.000	TON
PERFORMANCE GRADED BINDER (64-34) FOR STATE MAINTENANCE PATCHING	6.800	TON
PERFORMANCE GRADED BINDER (64-34)	702.780	TON
TACK COAT	27,780.000	GAL
RENTAL OF LOADER, FULLY OPERATED	50.000	HOUR
RENTAL OF MOTOR GRADER, FULLY OPERATED	50.000	HOUR
RENTAL OF DUMP TRUCK, FULLY OPERATED	50.000	HOUR
RENTAL OF SKID LOADER, FULLY OPERATED	50.000	HOUR
COLD MILLING, CLASS 3	590.300	STA
COLD MILLING, CLASS 5	1,428.000	SY
RAP INCENTIVE PAYMENT FOR STATE MAINTENANCE PATCHING	340.000	EACH
RAP INCENTIVE PAYMENT	35,139.000	EACH
ASPHALT PAVEMENT SMOOTHNESS TESTING I/D	1.000	LS
PERMANENT PAVEMENT MARKING, PAINT	140,000.000	LF

SUMMARY OF QUANTITIES AND LOCATION OF SURFACED INTERSECTIONS

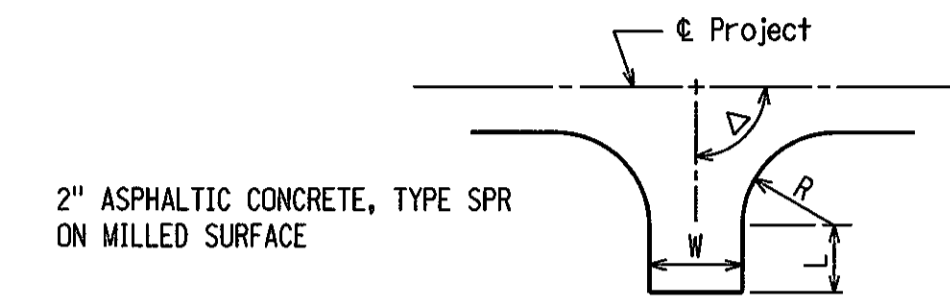

STATION	SIDE	R FEET	W FEET	L FEET	Δ DEGREE	PLACEMENT SQUARE YARDS	ASPHALTIC CONCRETE TONS	COLD MILLING CLASS 5
1144+30	RT	50	24	-	90	253	28	253
1385+01	LT	50	24	-	90	253	28	253
1543+34	LT	50	24	-	90	253	28	253
1622+30	RT	50	24	-	90	253	28	253
1701+12	RT	50	24	-	90	253	28	253

SUMMARY OF QUANTITIES AND LOCATION OF SURFACED DRIVEWAYS

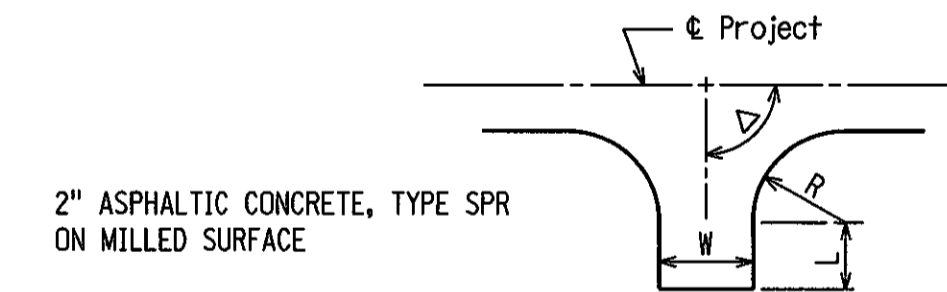

STATION	SIDE	R FEET	W FEET	L FEET	Δ DEGREE	PLACEMENT SQUARE YARDS	ASPHALTIC CONCRETE TONS	COLD MILLING CLASS 5
1333+92	LT	25	24	25	90	163	18	163

TYPES OF ASPHALTIC OIL TO BE USED
TACK COAT: SS-1, SS-IH, CSS-1, CSS-IH, CFS-1, FS-1
PERFORMANCE GRADED BINDER
AASHTO DESIGNATION M320



TRAFFIC ENGINEERING DIVISION

Computer: DRTRAFFIC20

User: dbr23056

Date: 20-MAY-2014 15:27

File: ptemp-1 r5.dgn
Scale: 1:100

2 LANE ROADWAYS

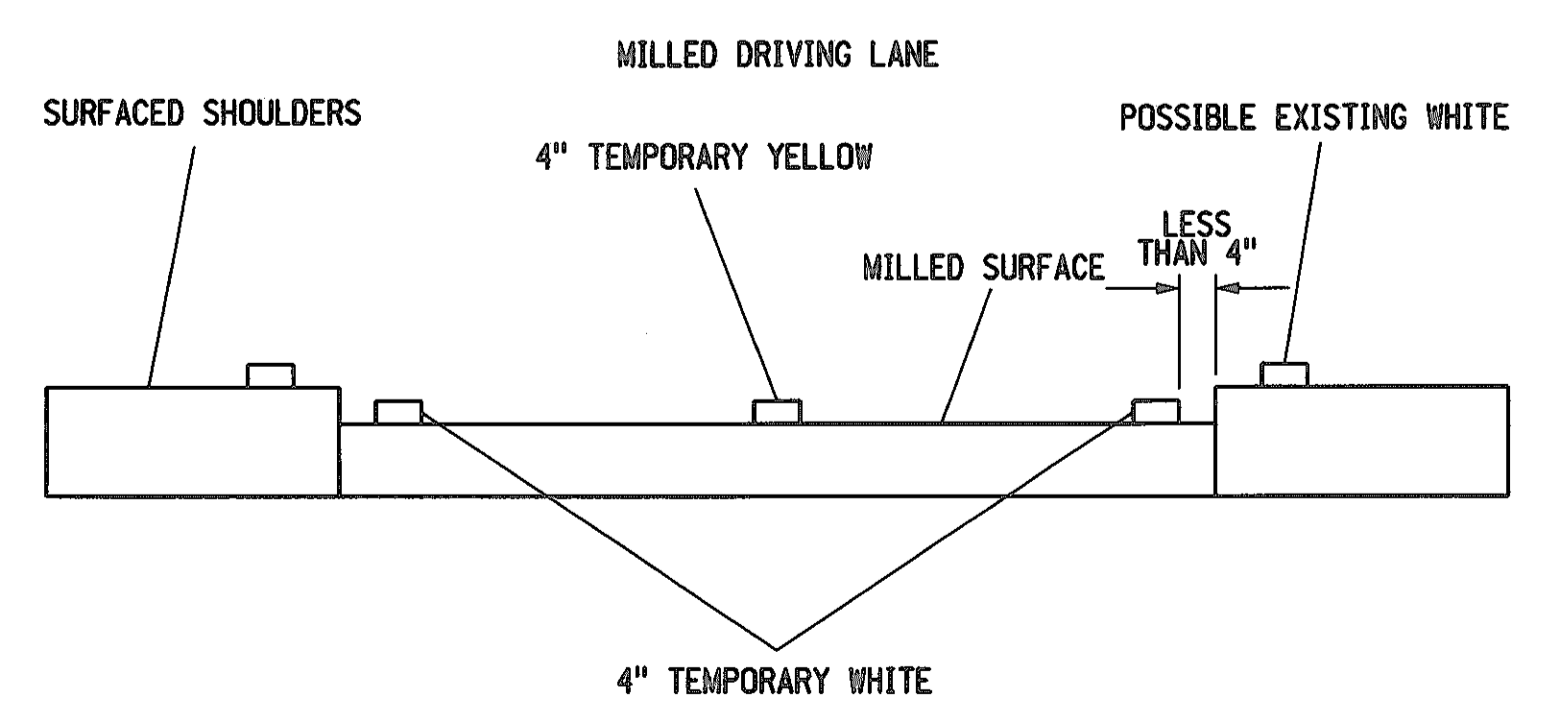
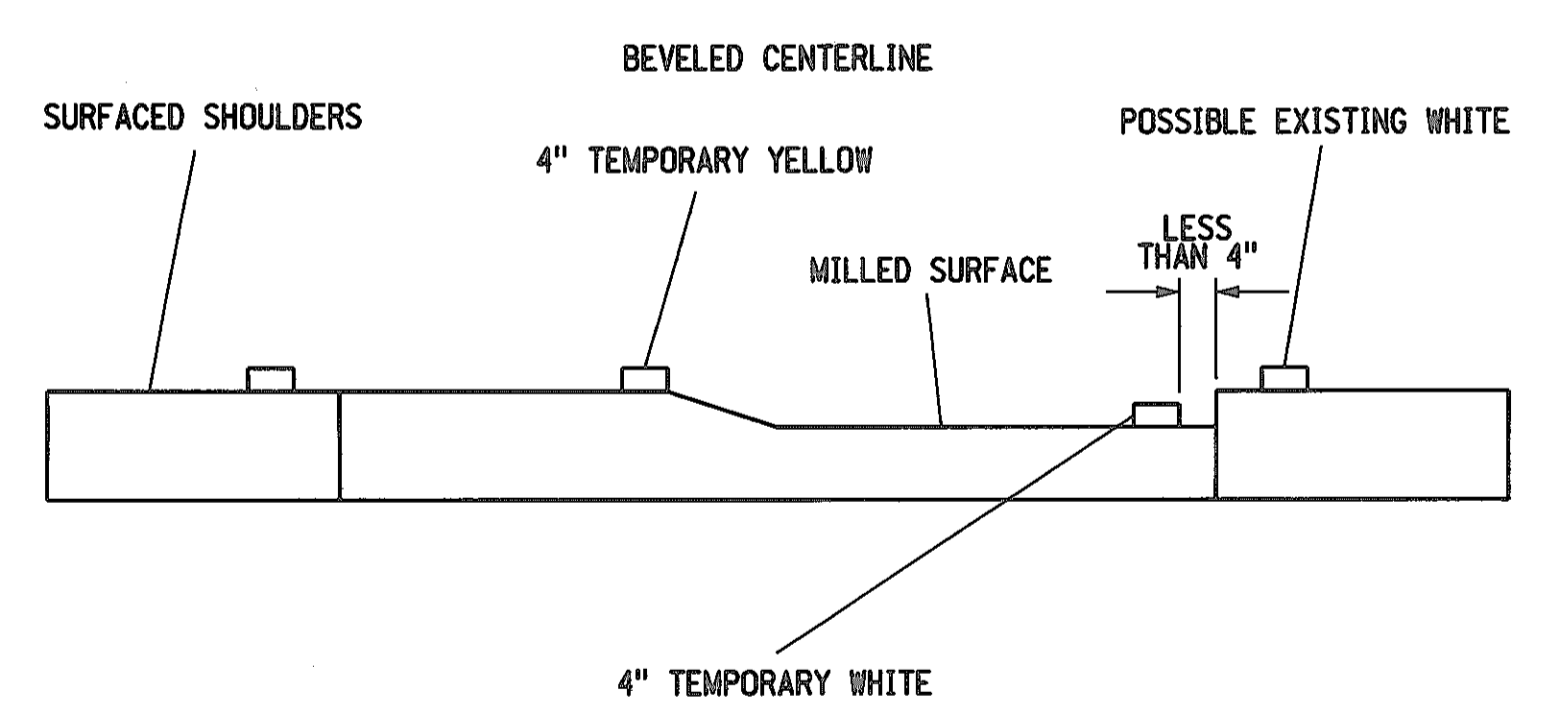
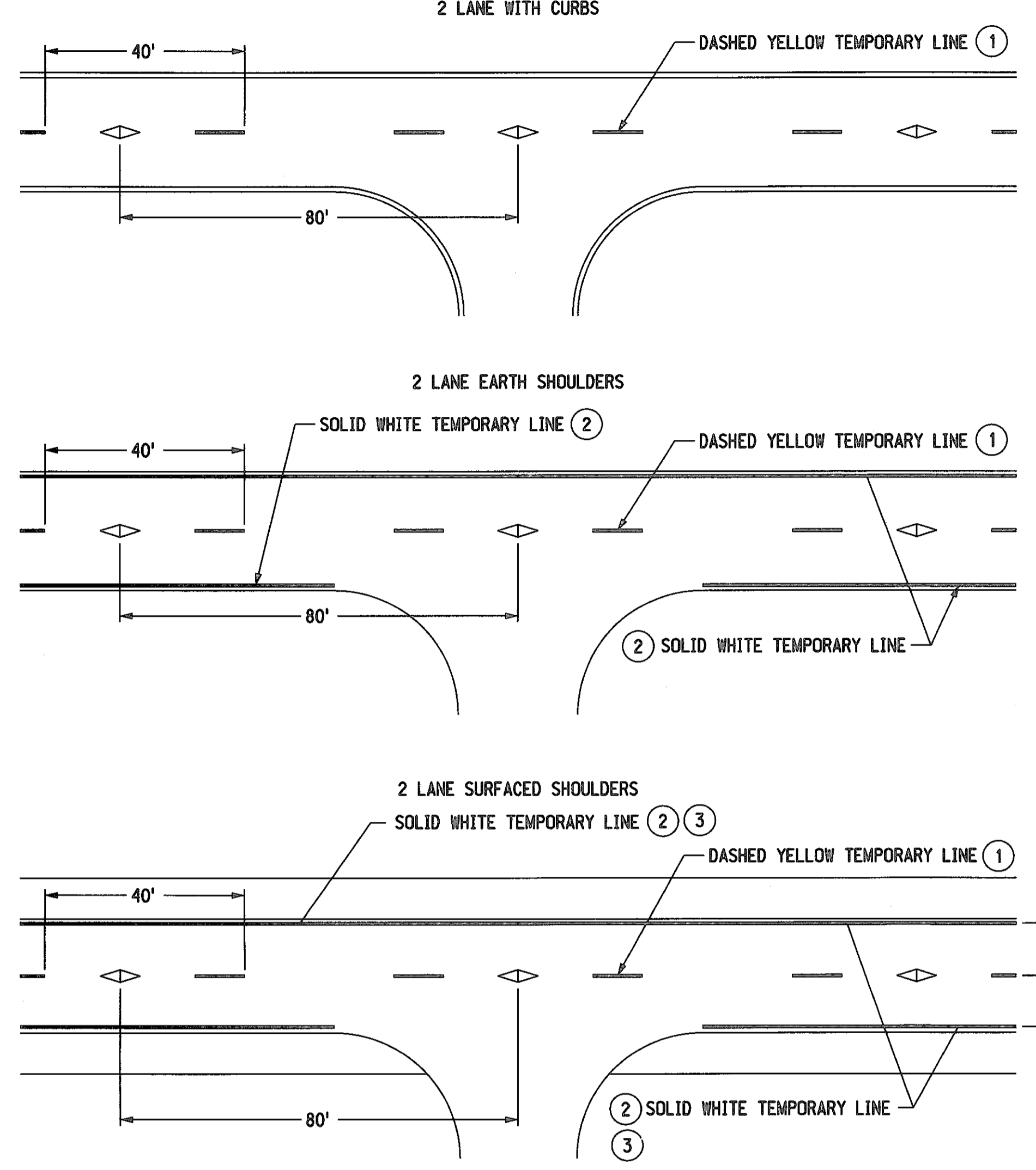

4 LANE ROADWAYS

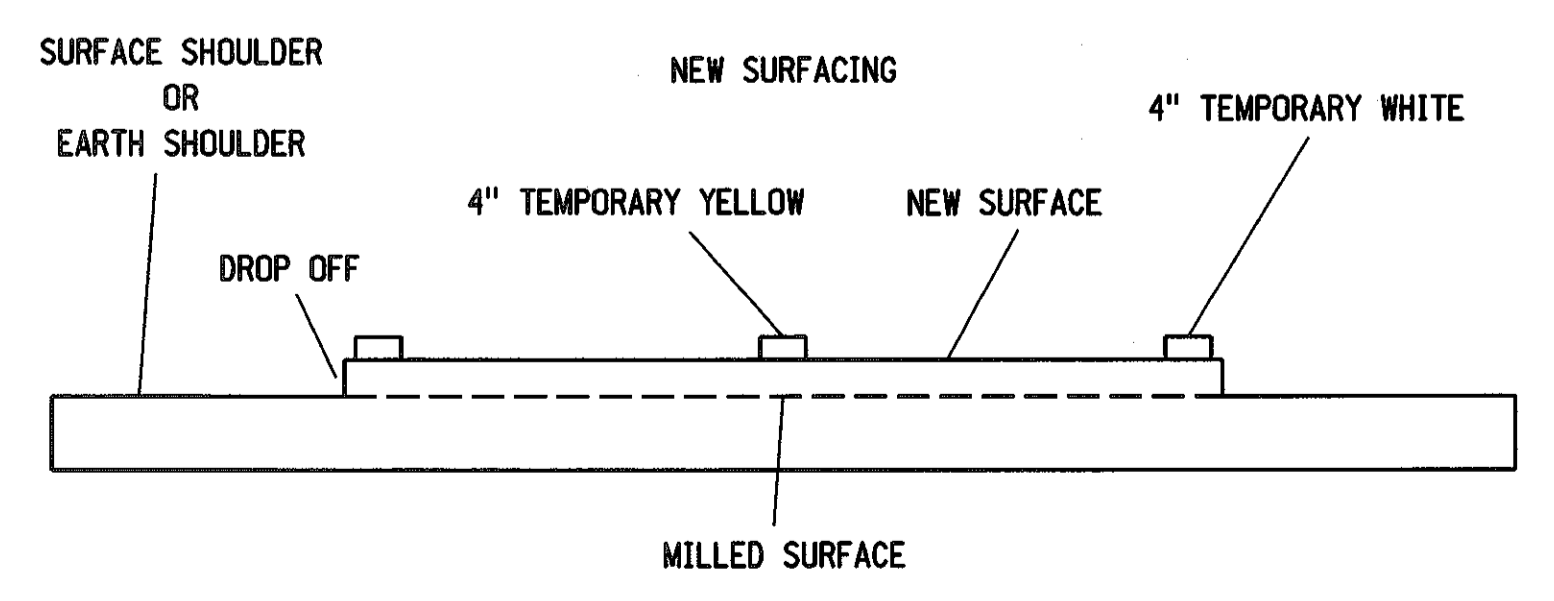
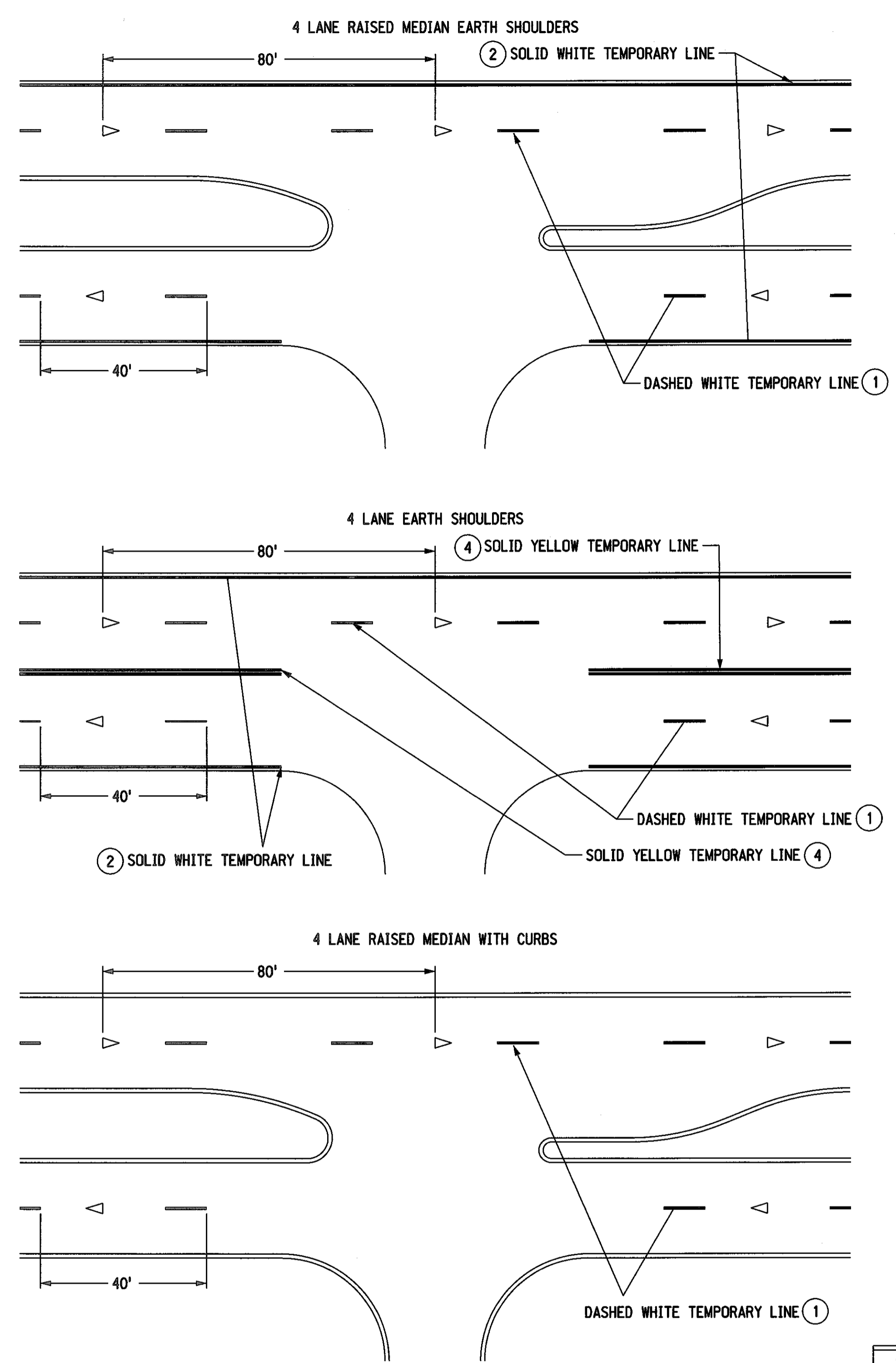

FREEWAY/RURAL EXPRESSWAY

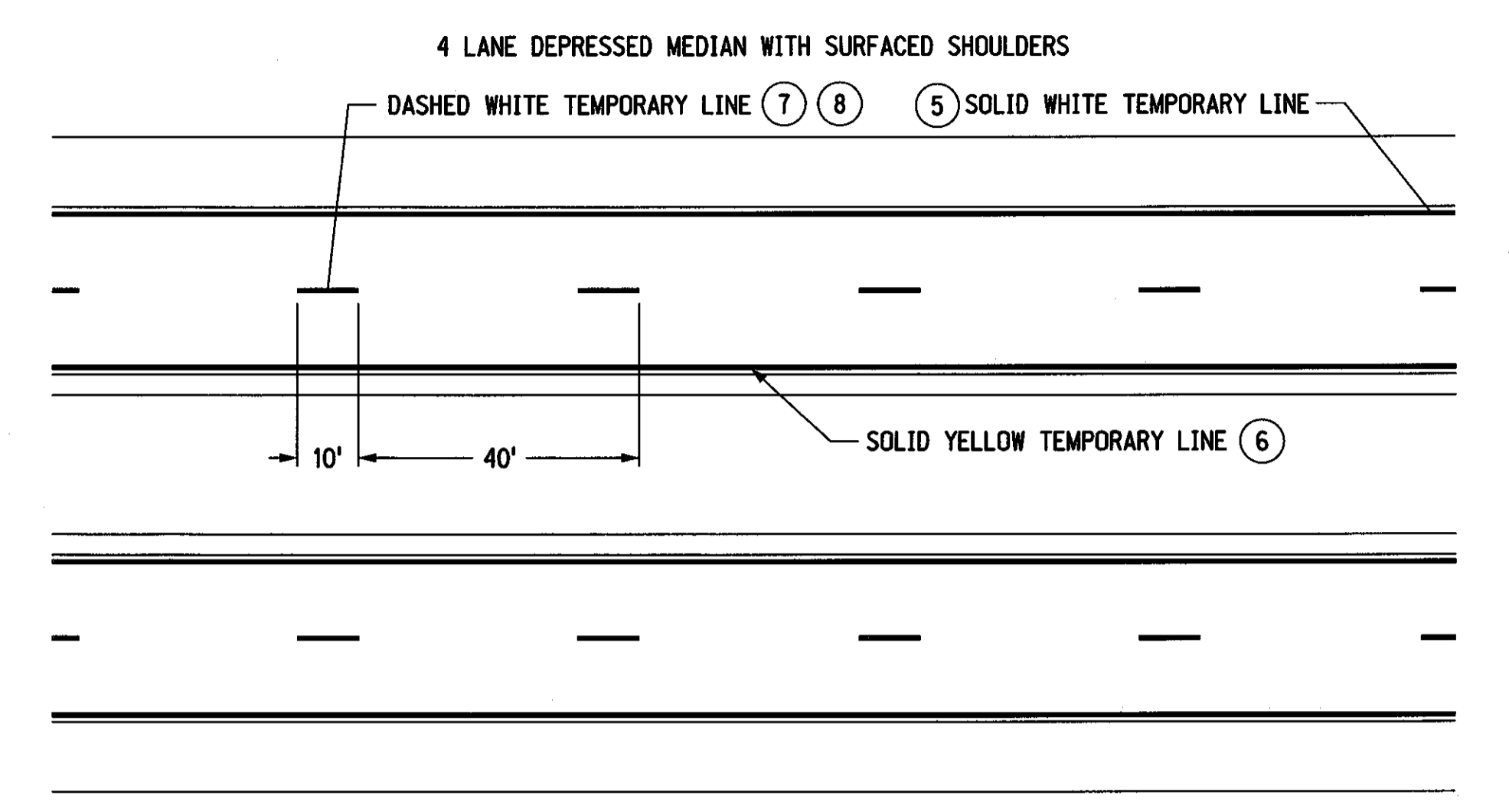

NOTES

- ① LOWER LAYERS: TEMPORARY DASHED LINE SHALL BE 4" X 10' PAINTED LINE AT 40' INTERVALS OR 4" X 4' TYPE I TAPE LINE AT 40' INTERVALS. TAPE OR PAINT WILL BE SUPPLEMENTED WITH AN OVERLAY MARKER EVERY 80 FEET.
 - OVERLAY MARKERS ARE NOT REQUIRED ON MILLED SURFACES, HYDRATED LIME SURFACES AND STABILIZED SURFACES.
- TOP LAYER: BROKEN LINE MARKINGS
 - INSTALL 4" X 4' TAPE AT 40' INTERVALS SUPPLEMENTED WITH AN OVERLAY MARKER EVERY 80 FEET.
 - OR USE NO TAPE, BUT INSTALL 2 RAISED PAVEMENT MARKERS SPACED 5' APART AT 40' INTERVALS.
- SOLID LINE MARKINGS
 - 4" WIDE PAINTED LINE OR PAVEMENT MARKING TAPE. RAISED PAVEMENT MARKERS MAY BE USED IN LIEU OF PAINT OR TAPE, INSTALLED AT 10' INTERVALS.
- ARMOR COATS
FOG SEALS: 2 OVERLAY MARKERS 5' APART, PER 40 FOOT CYCLE (NO PAINT OR TAPE).
- ② TEMPORARY SOLID LINE SHALL BE 4" WIDE PAINTED LINE.
- ③ EDGE LINE SHALL BE PLACED SO THAT THE OUTSIDE EDGE OF PAINT IS THE REQUIRED DISTANCE FROM CENTERLINE ON THE TOP LIFT
- ④ TEMPORARY CENTERLINE SHALL BE TWO 4" PAINTED LINES SPACED 4" APART, CENTERED ABOUT THE JOINT LINE.
- ⑤ EDGELINE SHALL BE 4" PAINTED LINE. PLACED TO THE LEFT OF JOINT LINE.
- ⑥ ALL LAYERS: EDGELINE SHALL BE PLACED 12'-0" FROM THE CENTER JOINT LINE. (RIGHT OF SHOULDER JOINT LINE WHEN APPLICABLE)
- ⑦ MILLED SURFACE OR LOWER LIFTS: THE TEMPORARY WHITE DASH LINE SHALL BE 4" X 10' MINIMUM PAINTED LINE AT 40' INTERVALS, PLACED TO THE LEFT OF THE JOINT LINE.
- ⑧ TOP LIFT: THE TEMPORARY WHITE DASH LINE SHALL BE 4" IN WIDTH X MINIMUM 8' TO MAXIMUM 10' LENGTH, PLACED 2" TO THE LEFT OF THE JOINT LINE. THE INTERVAL (CYCLE) SHALL BE 40' ± 2" TO ALLOW FOR THE PERMANENT PAVEMENT MARKING.
- ⑨ ALL TEMPORARY PAVEMENT MARKING THAT WILL BE COVERED BY PERMANENT PAVEMENT MARKING SHALL COMPLY WITH THE ALIGNMENT AND LOCATION REQUIREMENTS OF THE FINAL PAVEMENT MARKING MATERIAL. TEMPORARY PAVEMENT MARKINGS THAT ARE NOT COVERED BY THE PERMANENT MARKINGS SHALL BE REMOVED AT THE CONTRACTOR'S EXPENSE.

ROADWAY WIDTH	SHOULDER TYPE	DISTANCE FROM ϵ OF ROADWAY TO OUTSIDE EDGE OF PAVEMENT
LESS THAN 24'	SURFACED	EDGE OF LANE
LESS THAN 24'	EARTH	PAVEMENT EDGE
24'	EARTH	PAVEMENT EDGE
24'	SURFACED	12'-0" *
24' TO 28'	EARTH	12'-0" *

* SEE NOTE 3
CENTERLINE MARKING SHALL BE PLACED ON THE "SOUTH" SIDE OF THE CENTER JOINT ON EAST-WEST ROADS AND ON THE "EAST" SIDE OF THE CENTER JOINT ON NORTH-SOUTH ROADS

LEGEND

- ◁ OVERLAY MARKER
- ◁ BIDIRECTIONAL OVERLAY MARKER

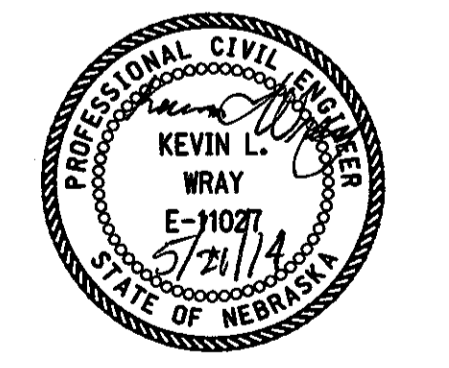

NEBRASKA DEPARTMENT OF ROADS TRAFFIC ENGINEERING DIVISION

DESIGNED DV	TEMPORARY PAVEMENT MARKING PLAN	①/①
REVIEWED MAN		
DATE DRAWN 8/06	TRAFFIC ENGINEER	DATE

TRAFFIC ENGINEERING DIVISION

Computer: DRTRAFFIC20

User: dor23056

Date: 20-MAY-2014 15:27

File: psptpm-2 r1.dgn
Scale: 1:100

2 LANE ROADWAYS WITH CURBS

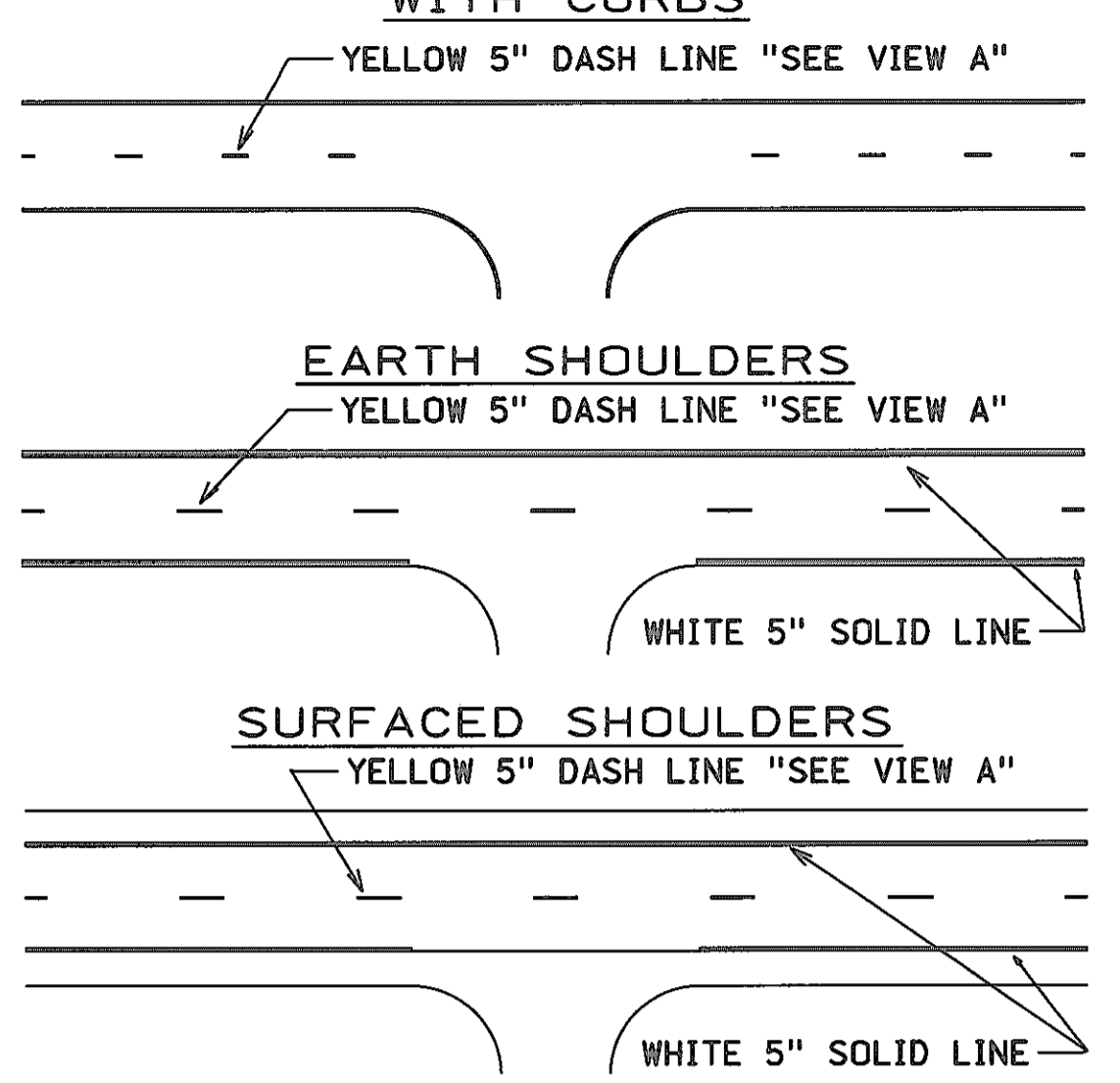

4 LANE DIVIDED ROADWAY

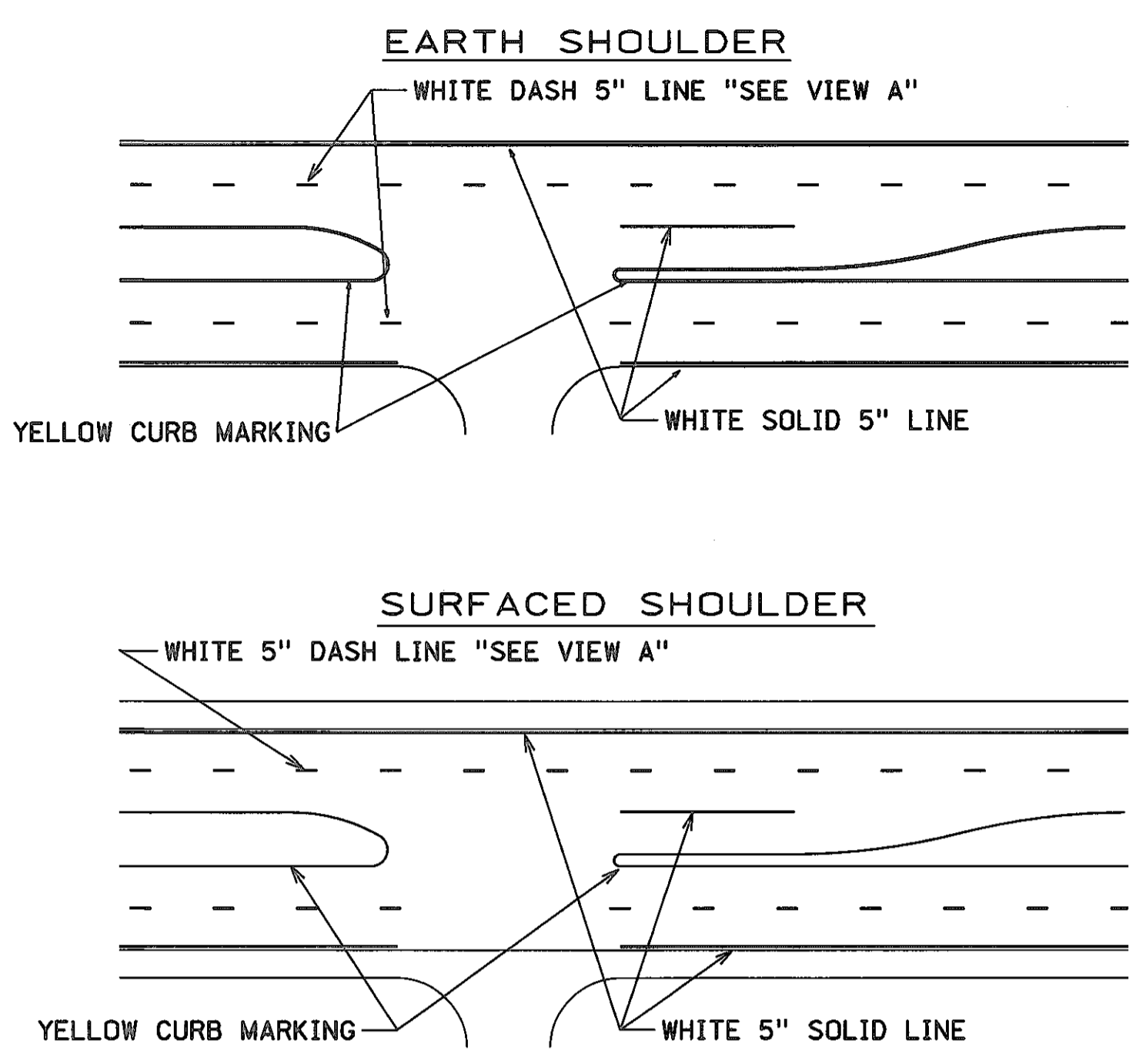

2-LANE ROADWAY REQUIRED LOCATION FOR EDGE LINES		
ROADWAY WIDTH	SHOULDER TYPE	DISTANCE FROM CENTERLINE OF ROADWAY TO OUTSIDE EDGE OF PAVEMENT EDGELINE
LESS THAN 24 FT	SURFACED	12 FT 0 IN
LESS THAN 24 FT	EARTH	PAVEMENT EDGE
24 FT	EARTH	PAVEMENT EDGE
24 FT	SURFACED	12 FT 0 IN
GREATER THAN 24 FT	EARTH	12 FT 0 IN

CENTERLINE MARKING SHALL BE PLACED ON THE "SOUTH" SIDE OF THE CENTER JOINT ON EAST-WEST ROADS AND ON THE "EAST" SIDE OF THE CENTER JOINT ON NORTH-SOUTH ROADS

4 LANE ROADWAYS NO CURBS

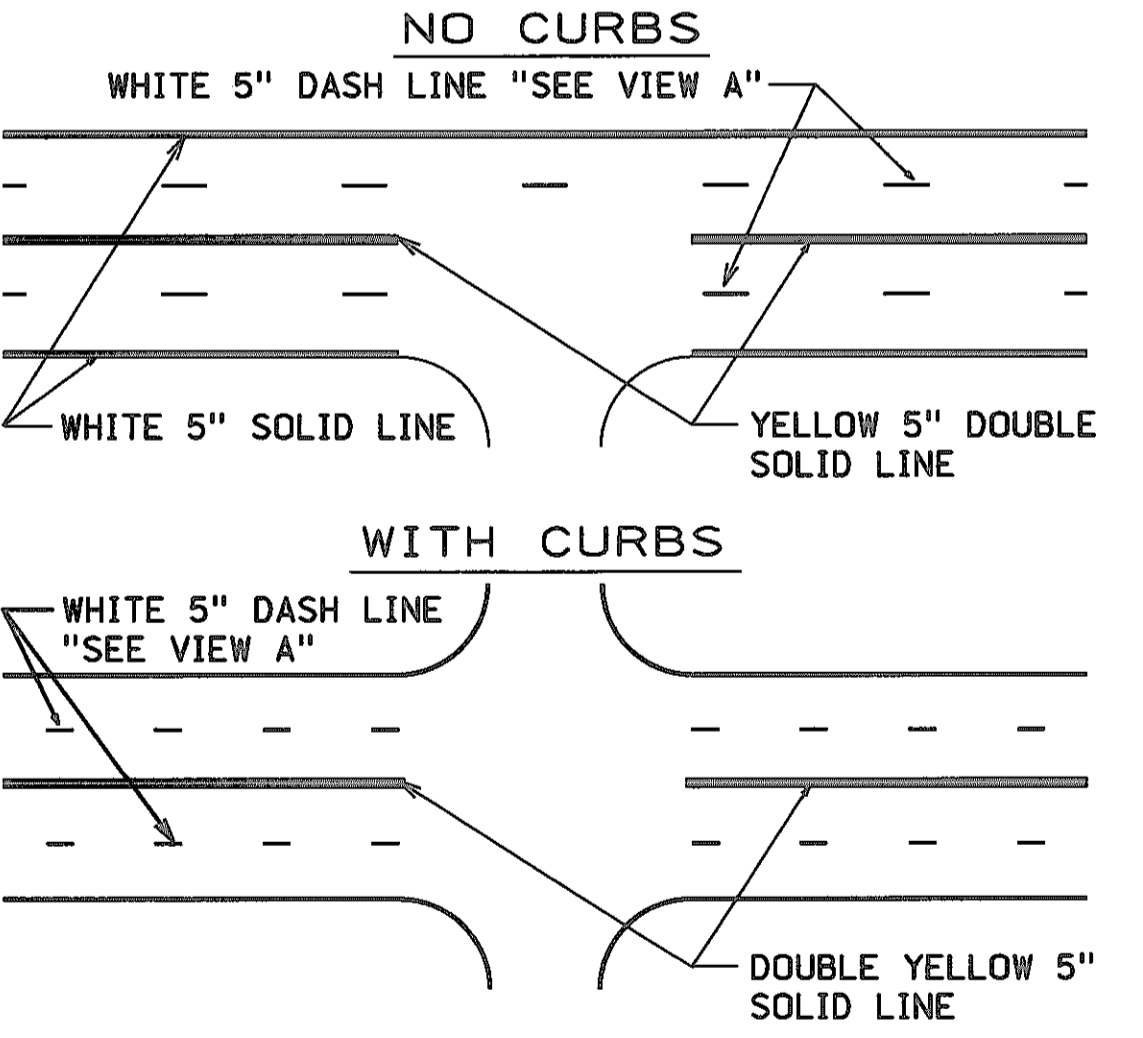

DEPRESSED MEDIAN

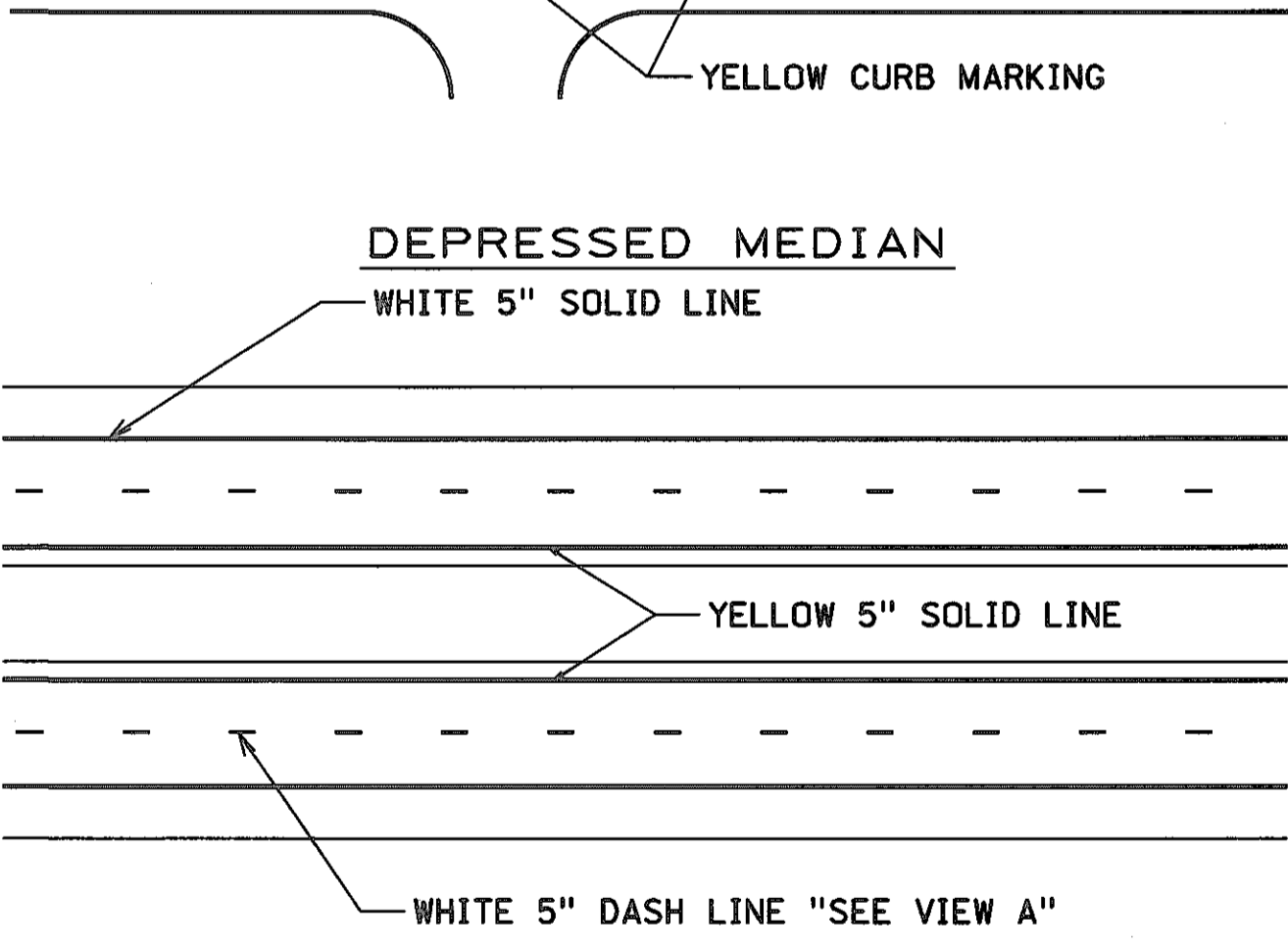

3 OR 5 LANE WITH COMMON LEFT TURN LANE

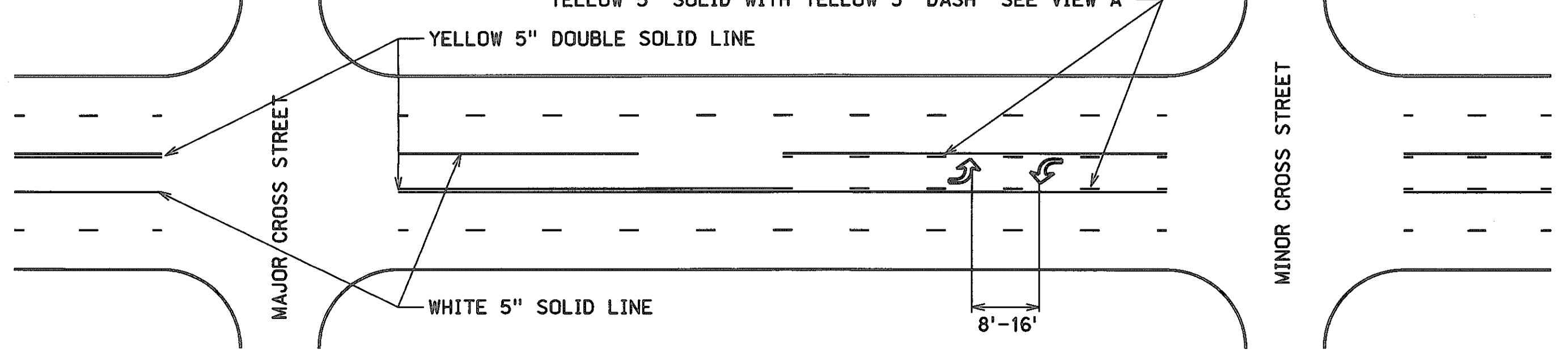

GORE MARKINGS (NON-FREEWAY)

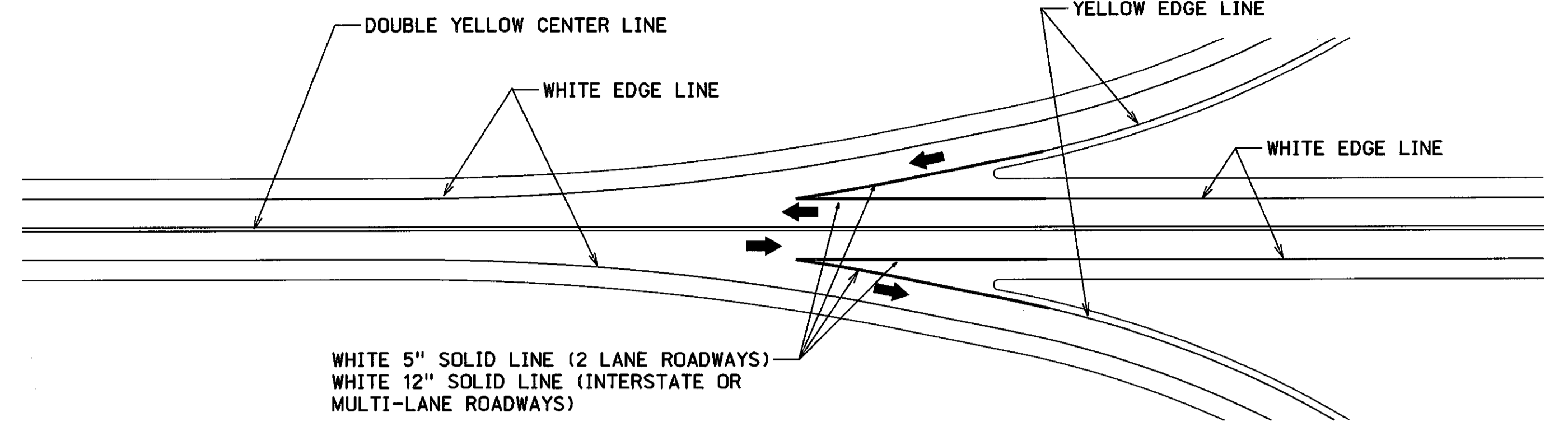

ISLAND MARKING

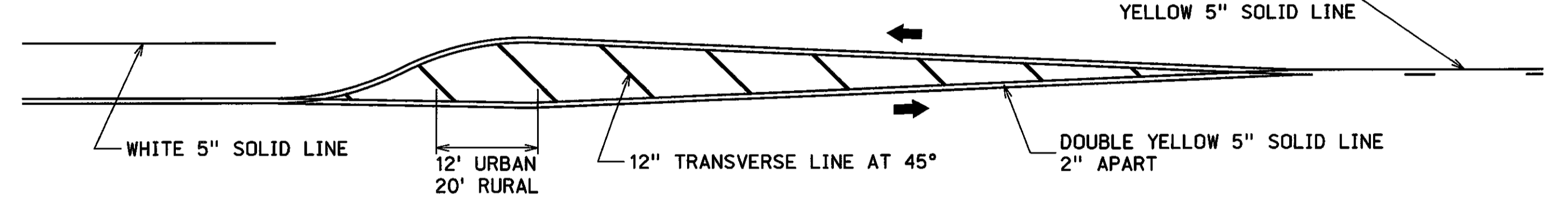

PASSING LANE MARKING

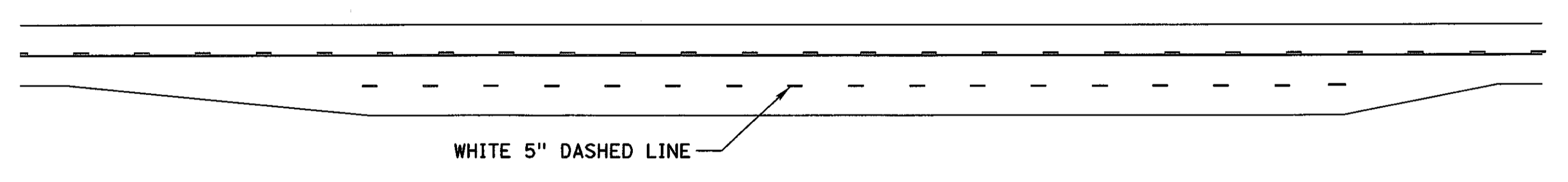

FLY-BY LANE MARKING

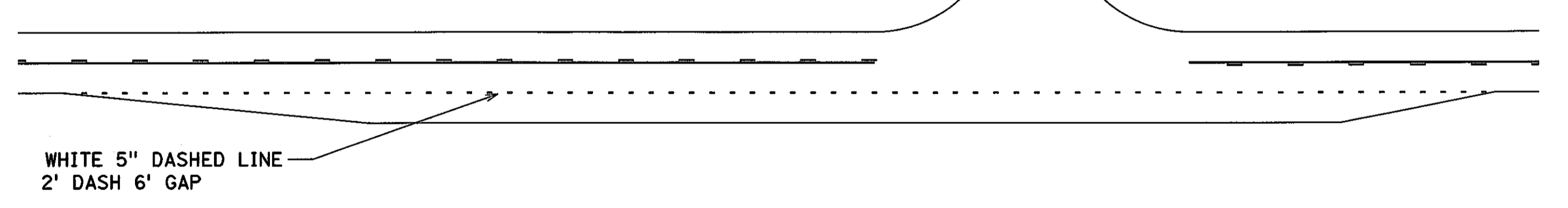

TYPICAL NO PASSING ZONE MARKINGS

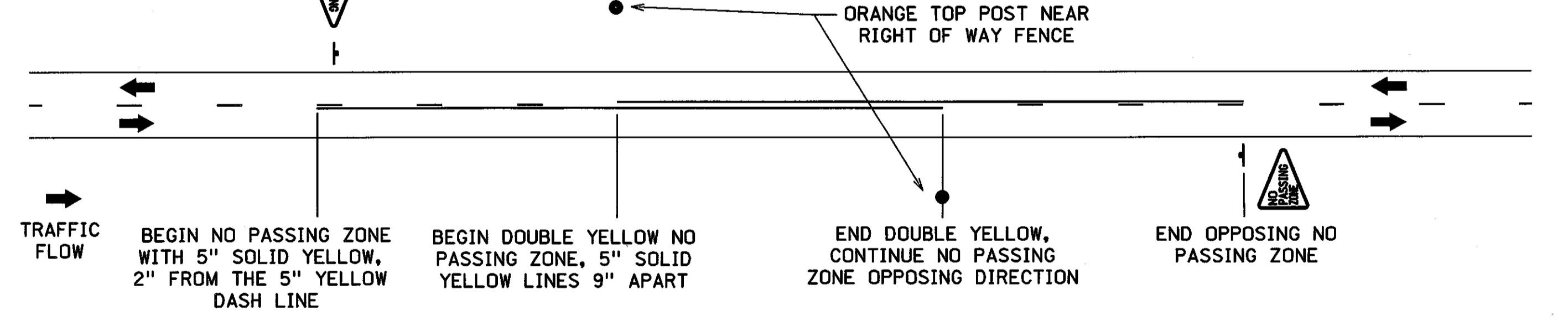

VIEW A

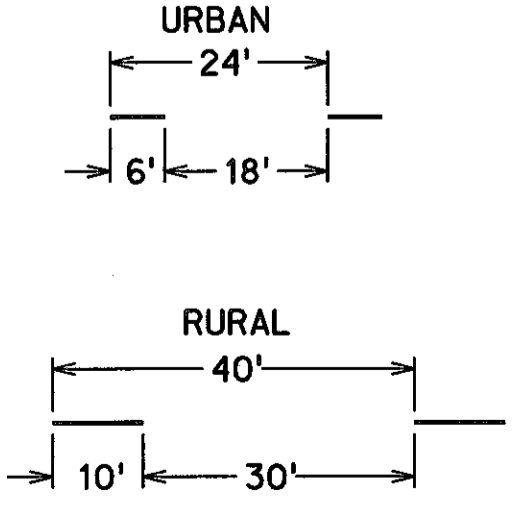

PERMANENT PAVEMENT MARKINGS INSTALLED IN GROOVES

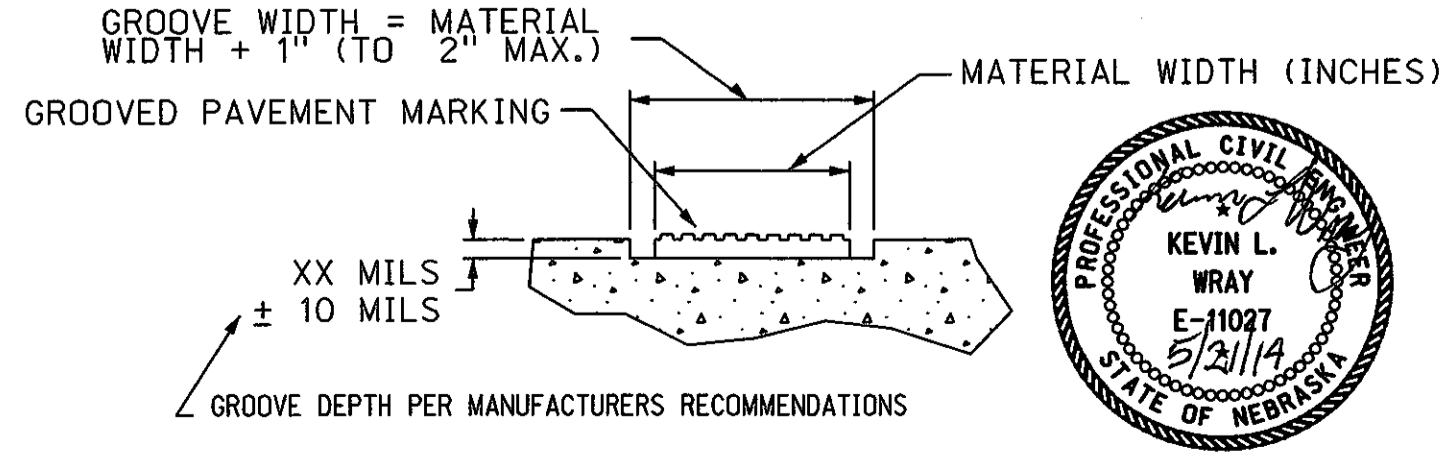

NEBRASKA DEPARTMENT OF ROADS TRAFFIC ENGINEERING DIVISION			
TYPICAL PAVEMENT MARKING PLAN			
DESIGNED	TJF	5" PAVEMENT MARKING	
REVIEWED			1/1
APPROVED	DATE DRAWN	TRAFFIC ENGINEER	DATE
	12/12		

SIGNING PLAN

STRIPING ON RURAL TWO-LANE TWO-WAY ROADS

STRIPING ON RURAL MULTI-LANE ROADWAY

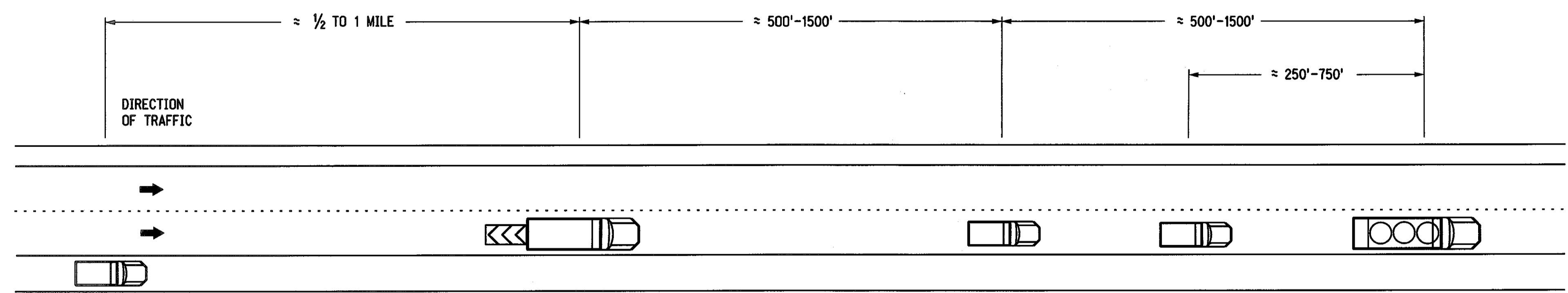
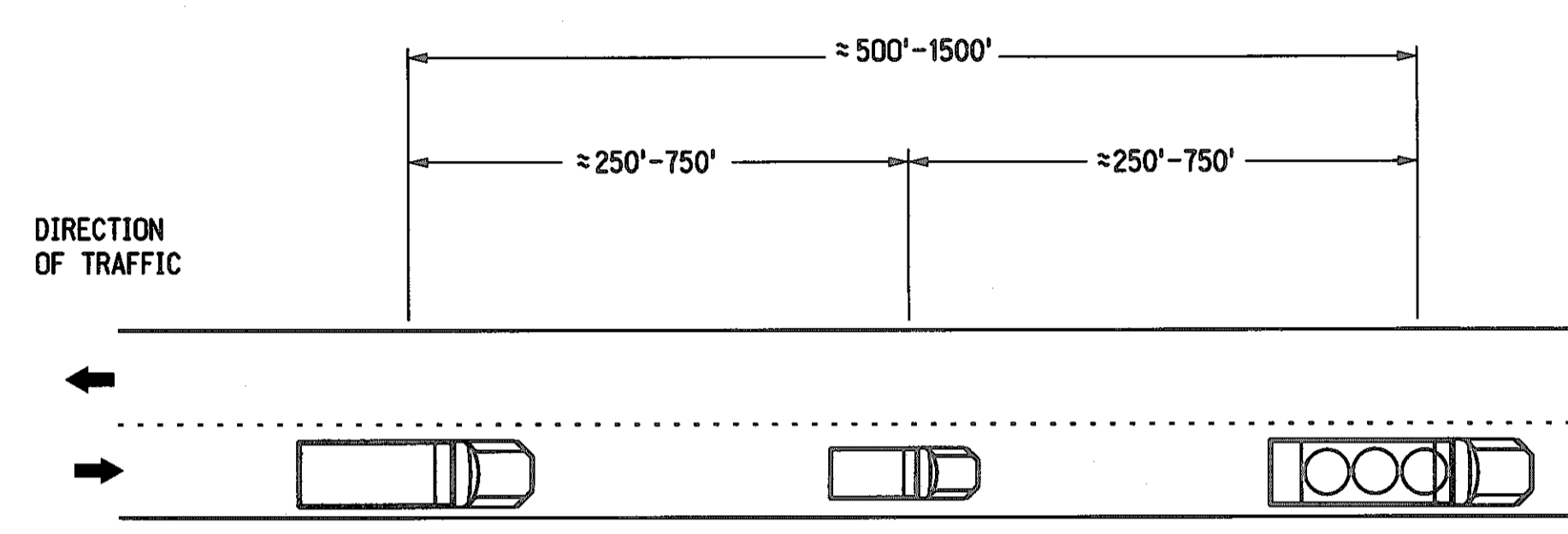

REAR VEHICLE
WITH 2 HIGH INTENSITY FLASHING LIGHTS MOUNTED ON THE REAR AND 2-360° BEACONS OR APPROVED MINI-BAR LIGHT (TMA OPTIONAL)

OPTIONAL VEHICLE
WITH 2-360° BEACONS OR APPROVED MINI-BAR LIGHT

STRIPING VEHICLE
WITH 4 HIGH INTENSITY FLASHING LIGHTS MOUNTED ON REAR AND 2-360° BEACONS OR APPROVED MINI-BAR LIGHT

WARNING VEHICLE
WITH 2 HIGH INTENSITY FLASHING LIGHTS MOUNTED ON REAR AND 2-360° BEACONS OR APPROVED MINI-BAR LIGHT

REAR VEHICLE W/TMA
WITH 2 HIGH INTENSITY FLASHING LIGHTS MOUNTED ON THE REAR AND 2-360° BEACONS OR APPROVED MINI-BAR LIGHT

TRAILING VEHICLE
WITH 2-360° BEACONS OR APPROVED MINI-BAR LIGHT AND OPTIONAL DRONE RADAR OR CB ALERT WARNING RADIO

OPTIONAL VEHICLE
WITH 2-360° BEACONS OR APPROVED MINI-BAR LIGHT

STRIPING VEHICLE
WITH 4 HIGH INTENSITY FLASHING LIGHTS MOUNTED ON REAR AND 2-360° BEACONS OR APPROVED MINI-BAR LIGHT

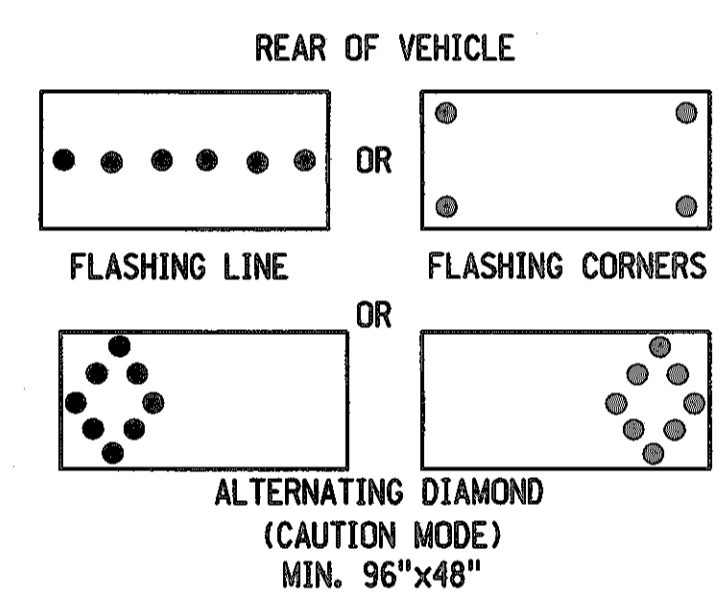

FRONT OF STRIPER
T-723
72" X 36"
SINGLE STROBE LIGHT ON FRONT OF STRIPER
REAR OF STRIPER ARROW PANEL

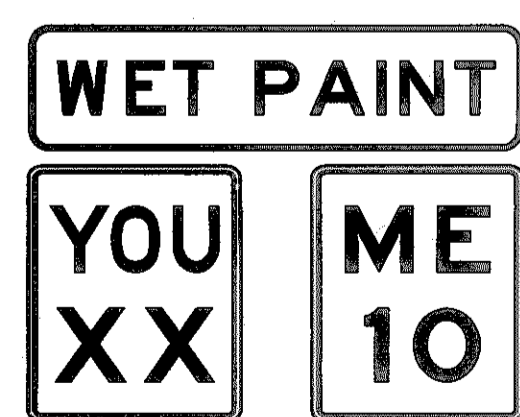
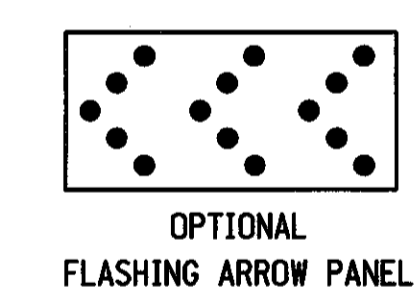
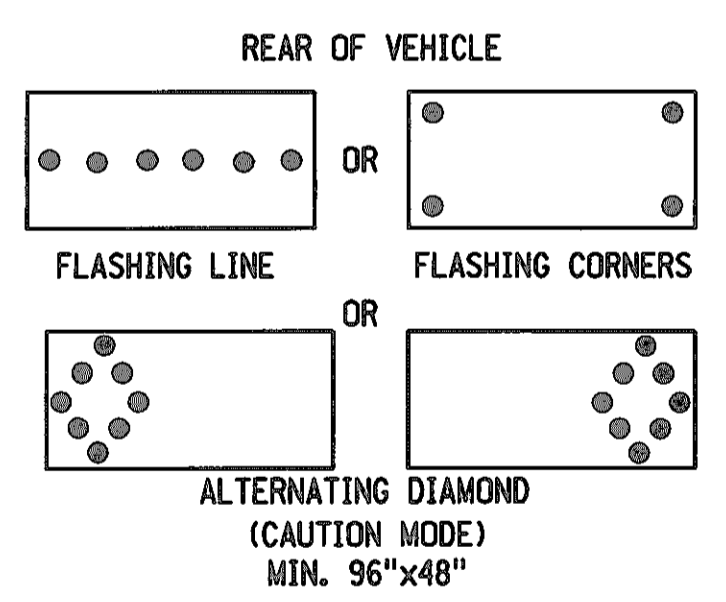
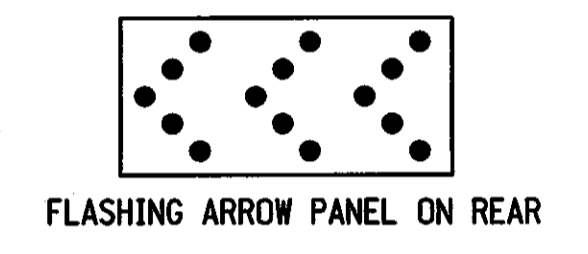
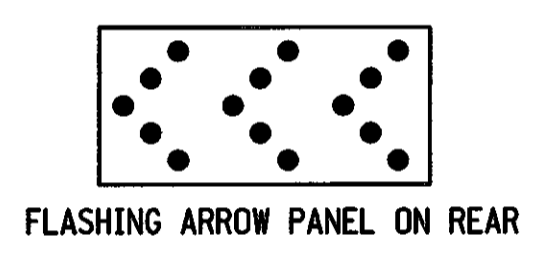
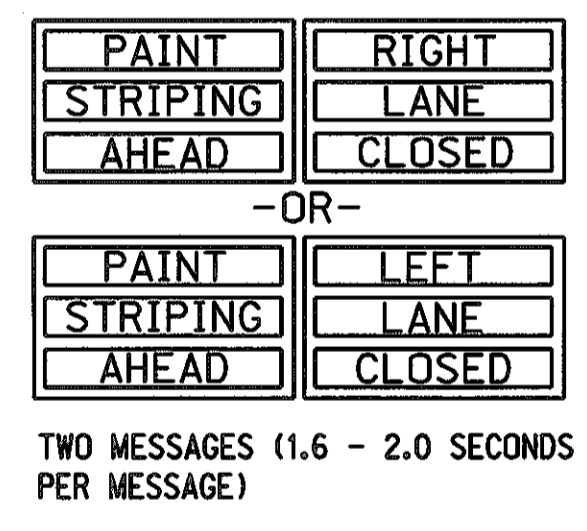
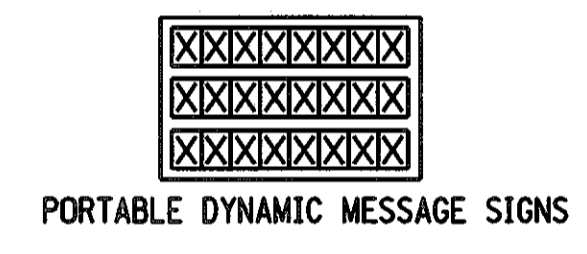

SIZE OF SIGN TO BE DETERMINED BY CONSTRAINTS OF STRIPER

TRUCK MOUNTED ATTENUATOR SYSTEM:

1. THE CONTACTOR SHALL FURNISH A FEDERALLY APPROVED TRUCK MOUNTED ATTENUATOR SYSTEM, MOUNTED ON A MINIMUM 16,000 POUND TRUCK. THE TRUCK SHALL BE EQUIPPED WITH 60" X 30" FLASHING ARROW PANEL, SECURELY MOUNTED ON THE TRUCK. THE TMA SYSTEM SHALL BE LOCATED IN THE FIELD AS REQUIRED BY THE MANUFACTURER. A COMPLETE SET OF REPLACEMENT MODULES SHALL BE AVAILABLE NEAR THE PROJECT SITE IN THE EVENT OF DAMAGE TO THE INSTALLED TMA. DAMAGED TMA'S SHALL BE REMOVED FROM THE ROADWAY AND PROJECT WORK STOPPED UNTIL REPAIRS TO THE UNIT HAVE BEEN COMPLETED.
2. THE TRUCK MOUNTED ATTENUATOR SHALL BE AN NCHRP 350 OR MASH TEST LEVEL 3 APPROVED TMA FOR 100 km PER HOUR (60 MPH).
3. THE TRUCK SHALL BE A 16,000 TO 35,000 POUND (GVW) VEHICLE AS REQUIRED BY THE TMA MANUFACTURER.
4. THE FLASHING ARROW PANEL SHALL BE SECURELY MOUNTED AS HIGH AS PRACTICABLE ON THE VEHICLE. THE ARROW PANEL SHALL NOT COME LOOSE UPON IMPACT TO THE TMA.



RURAL MULTI-LANE NOTES:

1. WHEN WORKING ON INSIDE (LEFT) LANES VEHICLES SHALL MOVE TO SIMILAR POSITIONS IN THAT LANE.
2. WARNING VEHICLE WILL REMAIN ON RIGHT SHOULDER WHEN AN 8' OR WIDER PAVED INSIDE (LEFT) SHOULDER DOES NOT EXIST.
3. REAR VEHICLE WITH TMA SHALL NOT BE SUPPLY VEHICLE UNLESS PAINT IS UNLOADED.

GENERAL NOTES:

- REAR VEHICLE SHALL BE PLACED IN ADVANCE OF HORIZONTAL OR VERTICAL CURVES TO PROVIDE ADVANCE WARNING FOR WORK OPERATIONS HIDDEN BY CURVES.
- VEHICLE SPACING MAY VARY DEPENDING ON RATE OF APPLICATION, SPEED, AND DRYING TIME.
- WHEN OPTIONAL CB ALERT WARNING RADIOS ARE USED THE TRANSMITTER MUST REMAIN WITH ONE OF THE VEHICLES IN THE STRIPING TRAIN.

RURAL TWO-LANE NOTES:

1. CAUTION MODE ON STRIPING UNIT AND REAR VEHICLE SHALL BE ALTERNATING DIAMOND OR THE FLASHING 4 CORNER LIGHTS IF THE DIAMOND MODE IS NOT AVAILABLE.

NEBRASKA DEPARTMENT OF ROADS TRAFFIC ENGINEERING DIVISION			
PAVEMENT MARKING PLAN			
DESIGNED	TJF	VEHICLE SIGNING FOR PAINT STRIPING	
REVIEWED			1/1
APPROVED	DATE DRAWN 12/12	TRAFFIC ENGINEER	DATE

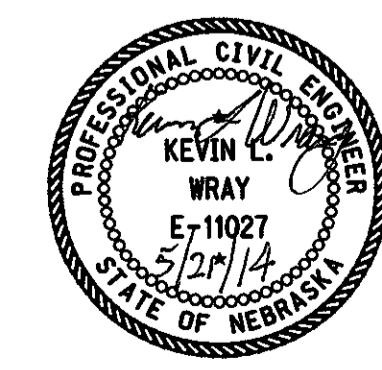

TRAFFIC ENGINEERING DIVISION

Computer: DRTRAFFIC20

User: dor23056

Date: 20-MAY-2014 15:26

File: wetpaint r1.dgn
Scale: 1:100